

**MO
AB
80**
houselab

T +39 0774 374222
F +39 0774 374190
E info@moab80.it
W www.moab80.it

Sede operativa - Operative center:
via Lago dei Tartari 20
00012 Guidonia Montecelio (RM), Italy

Sede legale - Registered office:
Strada Provinciale Quartaccio s.n.c.
01034 Fabrica di Roma (VT), Italy

Moab 80

**MO
AB
80**
houselab

02 **PROFILO AZIENDALE**
COMPANY PROFILE

ARREDI / FURNITURE

14 **ZERO20**

INDUSTRIAL LINE

52 Re-used top ITR
72 Top a fascia ITF / *edging strip top ITF*
92 Top lamiera stirata ITL/metal sheet top ITL
98 Lavabi d'appoggio acciaio IIA / IIA steel sink
112 Lavabi sottopiano acciaio ILUV / ILUV steel sink

DOOR

118 Teak stripes
138 Re-used
150 Pop
154 Tranché

BLOCK2

162 Top h12 per lavabi sottopiano:
h12 top with undertop wash basins:

164 Top Prefinito Cemento, Prefinito Calce
176 Top Corian®
188 Top laccati L.L. / *L.L. painted top*
194 Top essenze di legno / *wooden top*

208 Top h12 per lavabi d'appoggio
h12 top for above inserted wash basins

210 Mobili per lavabi d'appoggio
Units for above inserted wash basins

220 Mobili per lavabi sottopiano
Units for under top wash basins

230 **BLOCK**

242 **P40**

248 **SHELF**

LAVABI ARREDO / WASH BASINS

258 **LINEA** (Corian®)

266 **AIS** (Corian®)

272 **ELLE - ELLEDUE - ELLETRE** (cemento / *cement*)

SUPERFICI / SURFACES

316 **PREFINITO CEMENTO**

340 **PREFINITO CALCE**

ACCESSORI / ACCESSORIES

360 **STRIP**

378 **ACCESSORI BLOCK**
BLOCK ACCESSORIES

380 **NINO**

ALTRO / OTHER

386 **M3**

388 **LUCE10**

396 **PIATTI DOCCIA MASSELLO DI TEAK**
SOLID TEAK SHOWER TRAY

400 **GRAFICI E COLORI**
DIAGRAMS AND COLOURS

Moab80 è un'azienda italiana a ciclo completo che, avvalendosi dell'esperienza acquisita in più di 30 anni di attività sul mercato nazionale ed estero, propone arredi e superfici per la casa di stile contemporaneo.

Il prodotto viene curato dall'azienda in tutte le sue fasi: ricerca, progettazione, produzione e commercializzazione; questa impostazione ha determinato una forte identità di marchio e la garanzia di una continuità di offerta, fortemente legata alla cultura del progetto. L'esperienza artigianale, la lavorazione industriale e la costante ricerca estetica e materica, hanno posizionato Moab tra le aziende capaci di esplorare ed interpretare alcune delle evoluzioni stilistiche e concettuali contemporanee, con proposte di arredo capaci di esprimere diverse aree di gusto dell'abitare e del vivere.

Il risultato è una eccezionale offerta di sistemi integrati, che consente di creare ambienti originali e variegati grazie anche al valore aggiunto della personalizzazione sartoriale e della distinzione.

Moab80 is an italian full cycle enterprise that, based on its 30 years of experience on the Italian and international markets, offers home furnishings and surfaces of contemporary style. The firm closely follows production from beginning to end, from the research and design phases to production and sale. This approach has resulted in a clearly identifiable, strong trademark that is a guarantee of the continuity of an offer closely linked to the project culture.

Moab's competence in the sector, its industrial processing methods and its constant research in the products' aesthetics and materials has earned it a place among those companies capable of exploring and of expressing several of the evolutions in contemporary styles and concepts with furnishing solutions ideal for various areas of living and life styles.

The result is an astounding array of integrated systems that allows to create original and varied living environments enriched by the added value of made to measure customization and distinction.





INTRODUZIONE AL CATALOGO MOAB80

Il catalogo è suddiviso in linee di prodotto allo scopo di favorire la lettura e la conoscenza dell'offerta Moab.

In realtà è un ampio sistema integrato e flessibile che offre la possibilità di personalizzare gli arredi tramite la combinazione delle linee tra di loro e delle numerose textures.

Va oltre il singolo oggetto a favore del concetto, per abbracciare una visione dell'interior strettamente connessa all'architettura della casa.

Gli strumenti progettuali a disposizione sono: il su misura, la personalizzazione stilistica e funzionale, la copertura delle diverse aree di gusto contemporanee, la varietà della materia e dei materiali, la possibilità di avere la stessa "pelle", grazie ai prefiniti calce e cemento, sia nei rivestimenti che nei mobili, intesi come scocche, ante e/o frontali dei cassetti.

L'utilizzo di queste qualità e la fantasia di chi le propone permettono di coprire una consistente varietà della domanda se non addirittura di stimolarla.

INTRODUCTION TO THE MOAB80 CATALOGUE

The catalogue is divided into product lines so as to make the reader's consultation of and acquaintance with all of Moab's production easier.

In actual fact, it is an ample integrated and flexible system that offers the client the opportunity to customize the furnishings by combining different lines and textures. This approach goes beyond the single object, in favour of the concept, so as to embrace a vision of interiors closely connected to home architecture.

The design tools available are: Made to measure, style and function customization, coverage of the various areas of contemporary taste, variety in matter and materials, the opportunity of having the same "skin" thanks to the use of Prefinito Calce and Prefinito Cemento products on floors and walls and on the furniture by applying them to frames, leaves and/or drawer fronts.

The application of these standards of quality and the imagination of our designers allow Moab80 to meet highly varied requirements and even to stimulate diversity in demand.

Ottone,
cemento,
marmo:
classico
contemporaneo.

*Brass,
cement,
marble:
contemporary
classic.*



Acciaio,
cemento,
legno di recupero:
informale
contemporaneo.

*Steel,
cement,
re-used wood:
informal
contemporary.*



Vetro retinato,
ottone,
rame,
acciaio:
contaminazioni.

*Wired glass,
brass,
copper,
steel:
contamination.*

Vetro retinato
cemento
legno di recupero
acciaio:
industrial
chic.

Wired glass
cement
re-used wood:
industrial
chic.



Zero20

Zero20 è un arredo dal volume geometrico, costituito da unità primarie e leggerezza formale; i materiali utilizzati sono quelli d'elezione industriale ormai consueti per il marchio Moab80, come il cemento, la calce, i legni nuovi e di recupero, a cui si aggiungono i metalli bruniti, (ottone e rame) e i vetri industriali: strettamente connessi alla forma e ai colori che coincidono con quelli del materiale. Giustapposti ai materiali contemporanei più poveri, gli antichi metalli acquistano una nuova vita in una sorta di contaminazione e di sintesi estetica contemporanea.

La scocca esterna è di lamiera di alluminio verniciata o in rame brunito che può essere abbinata alle ante in: metallo brunito, legni, legno di recupero, calce, cemento, vetro industriale e tutte le finiture standard in catalogo.

Completa l'arredo l'ampio lavabo sospeso, con scarico a scomparsa, in lamiera di acciaio verniciata a colore.

Zero20 is a minimal geometrical shape unit, where the proposed finishings and materials such as Prefinito Cemento, Prefinito Calce, new/re-used wood, burnished metal (brass and copper) and wired glass, regularly used in industry continue the innovation process started with "Industrial Line".

The burnished metals, matched with the raw contemporary material, synthesize a new esthetical contemporary concept.

The external body is made out with painted aluminium sheet or burnished copper matchable with doors in: Burnished metal, wood, re-used wood, Prefinito Calce, Prefinito Cemento, wired glass including the standard finishing of Moab range.

Top it all: the wide painted aluminium sheet wash basin designed with hidden waste.

Aggregazione degli elementi storage, nelle varie modularità e finiture frontali.

Le scocche in metallo sono disponibili nei vari colori di serie.

Grouping of storage elements, with varying modular solutions and front finishing. The metal frames are available in the various serial colours.



Vista frontale degli arredi che rivela il rigore della struttura, il gioco dei vuoti e dei pieni nei volumi, ed alcune delle possibili finiture. Da sx: elemento con cassetto in teak orizzontale e vano a giorno, lavabo nero; seguono i contenitori con le finiture in Prefinito Cemento grigio chiaro, coordinati ai rivestimenti a parete, e in legno re-used (abete da cantiere). Le scocche sono nere opache.

Front view of furnishings that highlights the rigorous line of the structure, the contrast between full and empty volumes, and some of the finishings available. From left to right: element with horizontal teak drawer and open space, black washbasin; containers with light grey Prefinito Cemento finishing, to match the wall finish, and re-used wood (coarse spruce). The frames are matt black.





Particolare del lavabo Z20L colore nero opaco. *Detail of the matt black Z20L wash-basin.*

Particolare della superficie piana da cui si percepisce l'alternanza dei "pieni" e dei "vuoti" determinati dalle superfici d'appoggio dei contenitori e dal lavabo a pozzetto.

Detail of the flat surface that allows to perceive the alternated "full and empty volumes" defined by the bearing surfaces of the cabinets and of the tub-shaped washbasin.





Pavimenti, rivestimenti e contenitori con cassetti in Prefinito Cemento grigio chiaro, legno re-used, teak listellare e particolare del porta-oggetti a pozzetto e/o fioriera (Z20V).

Floors, walls and containers with drawers made using light grey Prefinito Cemento, re-used wood leaf, teak stripes and detail of the tub and/or flower box shaped vanity unit (Z20V).

Zero20 nella versione con i metalli ottone e rame bruniti, impreziositi dal rigore contemporaneo delle forme e del rivestimento in Prefinito Cemento colore grigio chiaro, realizzato in grande formato su misura.

Zero20 with ancient burnished metals, contaminated and enhanced by the rigorous contemporary line of the shapes and of the slabs, large sized and made to measure, in light grey Prefinito Cemento.





Composition made out of Z20L suspended wash-basin and two ZB411C cabinets (left and right) with drawer and open space. On the left: detail of the Z20L wash basin. Horizontal customised size mirror (art. LEDES2) with upper and lower LED.

Composizione realizzata con un lavabo sospeso Z20L e due contenitori ZB411C (sinistro e destro) con cassetto e vano a giorno. A sn: particolare del lavabo Z20L. Specchio orizzontale su misura art. LEDES2 con LED superiori ed inferiori.



Lavabo
realizzato
in lamiera
di acciaio,
disponibile
in diversi
colori, anche
a richiesta,
con scarico
tradizionale
nascosto dalla
traversa
ispezionabile;
è possibile
utilizzarlo
anche nella
versione
single (senza
contenitori).

*Steel sheet
washbasin,
available
in various
colours, even
at customer
request, with
traditional
drain hidden
by the sill;
can be used
in the single
version
(without
containers).*





Composizione realizzata con lavabo Z20L colore rosso pomodoro, contenitori con scocca nero opaco, cassetto con frontale Prefinito Cemento grigio antracite e ante in vetro retinato. Rivestimenti in Prefinito Calce nera e accessori serie STRIP.

Composition made out Z20L wash-basin, tomato red colored, matt black cabinets with dark grey Prefinito Cemento drawer and wired glass doors. Black Prefinito Calce wall coverings and STRIP bar and accessories.





Ambiente di ispirazione industriale realizzato con Prefinito Calce nera, vetro retinato industriale, acciaio verniciato rosso pomodoro e nero.

Living space inspired by the industrial style, obtained using black Prefinito Calce, industrial wired glass, steel painted in tomato red and black.

Gray beige Z20L wash-basin and ZB411C cabinet with sawn oak white drawer.

Lavabo Z20L e scocca del mobile ZB411C tortora con cassetto in rovere taglio sega bianco.





Composizione realizzata con lavabo in acciaio verniciato colore nero Z20L, mobile contenitore con scocca in rame brunito e cassetto in legno re-used ZB411CR. Specchio con cornice vassoio ZS157 colore nero.



Composition made out black varnished wash basin Z20L, burnished copper cabinet with "re-used" wood drawer ZB411CR. Mirror with black painted metal frame ZS157.



Dettaglio del cassetto aperto.
Opened drawer detail.



Lavabo Z20L bianco e mobile ZB409C bianco con cassetto in Prefinito Calce bianco.



White Z20L wash basin and white ZB409C cabinet with white Prefinito Calce drawer.



Composition made out with metal frame mirrors (burnished copper and white) and flush to covering mirror.

Composizione di specchi vassoio (rame brunito e bianco) e filo lucido.

Zero20 in purezza: bianco totale, con scocca in metallo verniciata e cassetti in Prefinito Calce.

Pure Zero20 cabinets: total white with white painted aluminium body and white Prefinito Calce drawers (ZB411C).





Per i piccoli spazi: lavabo Z20L, colonna ZB203 e accessorio Strip in acciaio verniciato bianco. Le ante del contenitore sono in Prefinito Cemento grigio chiaro in abbinamento ai rivestimenti della stessa materia.

For small spaces: Z20L wash basin, ZB203 tall unit and Strip bar and accessories, all white painted. The cabinet's doors are made out light grey Prefinito Cemento, according to the coverings' material.





Armadiatura realizzata con tre colonne Zero 20 con ante in Prefinito Cemento sabbia (ZB203) in abbinamento ai rivestimenti su misura della stessa finitura; effetto grafico e di alleggerimento dei volumi.

Wall system made out three tall units ZB203 (Zero20 series) with sand Prefinito Cemento doors, according to the customized wall covering slabs. The result is a graphic effect and volume lightening.

Di ispirazione living, pensili Zero20, personalizzabili per finiture e colori. Nelle immagini:
pensile cm 90 colore nero con anta vasistas in rame brunito ed anta in vetro retinato (art. ZP290).
Alla sua destra: pensile su misura cm 45 nero con anta in ottone brunito.

These Zero20 wall units came from living inspiration. They have many colors and materials combinations. In the pictures: black cm 90 wall unit with burnished copper "wind" door and wired glass door. On the right: black wall unit customized width (45 cm) with burnished brass.





In abbinamento alle basi e al lavabo in metallo, Zero20 presenta lo sviluppo di contenitori pensile, anch'essi personalizzabili tramite la combinazione di materie e cromatismi.

According to the metal cabinets and wash basin, Zero20 presents the development of wall units. They are also widely customizable thanks to the many possibility of combination of materials and colors.



Industrial Line

La parola giapponese *wabi* esprime un'idea di bellezza sotto forma di understatement: "forma nascosta del bello, qualità di raffinatezza mascherata di rusticità". E' il canone estetico di questo gruppo di prodotti che evocano atmosfere neo-industriali ricercate, apparentemente spartane, in realtà sofisticate. Lavabi in acciaio verniciato, piani in legno di recupero, abete sbiancato, leggeri piani in lamiera forata: sono i componenti di questa nuova famiglia di prodotti di matrice industriale, sia per i materiali d'elezione che per le fogge. Interpretazione contemporanea di uno stile informale che riflette scelte low tech. Oggetti amichevoli che, nella semplicità della funzione svelata, conferiscono all'ambiente in cui sono inseriti una precisa identità: quella del "riccio"!

The Japanese word - wabi - expresses the idea of beauty in an understated form: "beauty as hidden form, the quality of subtle refinement masked by rustic simplicity". These words sum up the aesthetic canon of this line of products, whose subtle neo-industrial atmospheres appear spartan but are really sophisticatedly luxurious. Steel painted washbasins, light tops of pierced sheet-metal, re-used, bleached wood. These are the components of this new family of products which bears an industrial stamp both in the nature of its chosen materials and in their fashioning. A contemporary interpretation of chic informal stylishness reflecting low tech options that aim for lightness and simplicity.

Friendly objects which, in the simplicity of their revealed function, give the environment which hosts them a precise identify: that of the "sea-urchin"!



Abaco delle componenti:
 List of components:

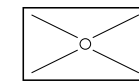

ILA60

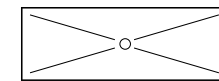

ILA100

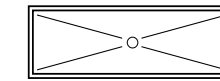

ILUV



D20L

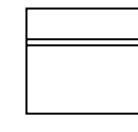

Z20L

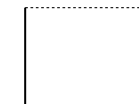

ITF

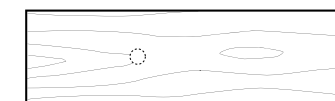

ITR

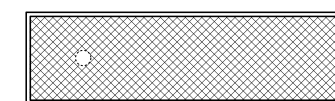

ITL160

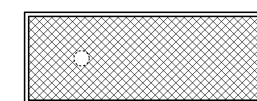

ITL120

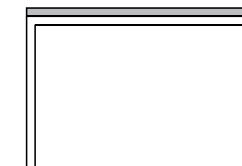
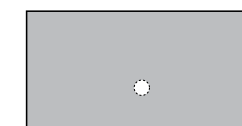

DESK

PIANO IN LEGNO DI RECUPERO (ITR)
RE-USED WOOD TOP (ITR)

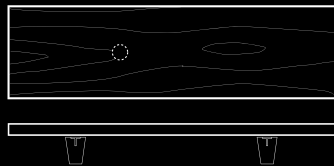

Ambiente realizzato con piano "re-used" in legno di recupero di abete (limited edition, cod. ITR), lavabo in acciaio grezzo ILA100 con traversa e mensola in lamiera stirata nera (ITL); lavabo in calcestruzzo LC45 colore sabbia (ELLE), contenitore colore nero opaco (Block2), asta porta salviette con specchio (Strip), pavimento e alzata-lavabo di rivestimento in Prefinito Cemento colore panna.

Solution obtained with "re-used" wood top (limited edition ref. ITR), ILA100 raw steel sink with black mesh sheet tray and shelf (ITL); sand-coloured (ELLE) LC45 concrete sink, matt black vanity unit (Block2), towel bar with mirror (Strip), floor and sink riser in milk white-coloured Prefinito Cemento slabs.

Unfinished stainless steel IIA100 sink, "re-used wood top", sink riser in milk white Prefinito Cemento slabs.



Lavabo IIA 100 in acciaio inox grezzo, piano "re-used" in legno di recupero di abete (ITR45), alzata-lavabo



in Prefinito Cemento colore panna.

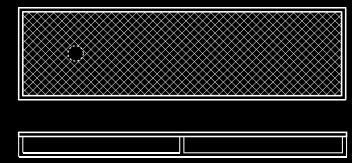
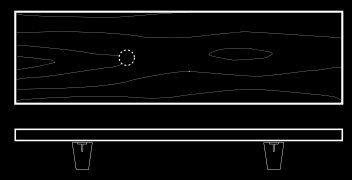



Re-used top and raw steel IIA100 wash-basin

Piano in legno di recupero, lavabo IIA100 in acciaio inox grezzo

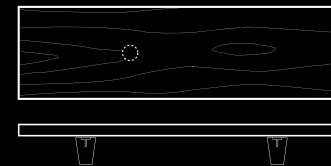

Composizione realizzata con il piano in legno "re-used", lavabo in acciaio spazzolato ILA100, contenitore a giorno su ruote in acciaio verniciato giallo art IC46R, disponibile anche nella versione a parete.

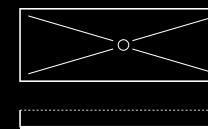

Composition obtained with "re-used" wood top, ILA100 brushed steel washbasin, open container on wheels in yellow painted steel item ref. IC46R, wall-mounted version also available.



Detail view from above, showing the graphic style of the furnishing exalted by colour and material matching.



Particolare dall'alto dove si apprezzano i grafismi dell'arredo esaltati dagli accostamenti cromatici e materici.

Particolare del lavabo sospeso in acciaio D20L con scarico tradizionale e traversa ispezionabile, in abbinamento con gli accessori STRIP, colore coordinato.

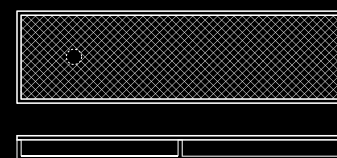
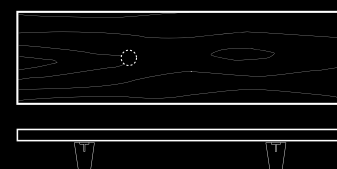

Detail of the wall mounting wash-basin D20L with hidden drain system (inspectable), in combination with Strip accessories in the same color.



Piano "re-used" ITR45 con lavabo da appoggio in Corian® (CLAT.P)

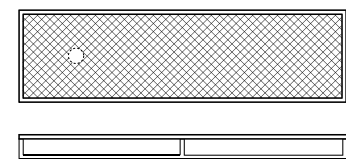
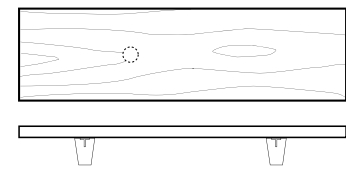

"Re-used" top ITR45 with Corian® washbasin (CLAT.P)





Piano "pop" (in abete sbiancato) ITP45 con lavabo d'appoggio in ceramica B2LC. Sulla parete rivestimenti su misura in Prefinito Calce colore fango, sgabelli NINO in Prefinito Calce bianco e fango.



"Pop" top ITP45 (bleached spruce) with ceramic above inserted wash basin B2LC. Prefinito Calce coverings and NINO stools in Prefinito Calce white and mud.

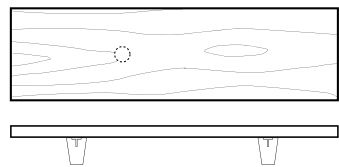

TOP A FASCIA FILOPIANO (ITF)
EDGING STRIP TOP (ITF)

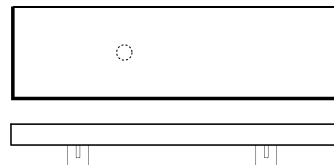

Top sospesi per lavabi d'appoggio con cornici in metallo "filopiano" cm h8, che ne esaltano le textures e creano caratteri diversi grazie ai numerosi abbinamenti possibili.

Cornici: disponibili in acciaio naturale o colorato, rame e ottone brunito.

Piani: tutte le finiture Moab, nell'immagine legno re-used (ITFR).

Tops defined by metal edging strip flush to the surface-top cm h8 that exalt the textures and evoke many different characters thanks to the wide range of possibile matches.

Edging strip are available in brushed or varnished stainless steel and burnished copper or brass.

Tops surface are available in all Moab80 finishing. On the picture is shown "re-used" wood top (ITFR).



Composizione realizzata con Piano ITFR cm 200, cornice nera e piano "re-used". Lavabo da appoggio ILA100 colore nero, completo di traversa in legno "re-used" ILAT, mobili cassetti neri della serie Block2 e accessori Strip, sempre neri della stessa altezza del lavabo. Il pavimento è dello stesso materiale del piano ma non è in vendita.



Composition made out ITFR top 200 cm wide, black edging strip and "re-used" wood top. Black above inserted ILA100 wash basin, completed by a "re-used" wood shelf ILAT, black Block2 drawers and Strip accessories, made out the same color and the same height of the ITF top edging strip.





Composizione realizzata con Piano ITFR cm 200, cornice nera e piano "re-used". Lavabo da appoggio ILA100 colore nero, completo di traversa in legno "re-used" ILAT, mobili cassetti neri della serie Block2 e accessori Strip, sempre neri della stessa altezza del lavabo. Il pavimento è dello stesso materiale del piano ma non è in vendita.

Composition made out with ITFR top 200 cm wide, black edging strip and "re-used" wood top. Black above inserted ILA100 wash basin, completed by a "re-used" wood shelf ILAT, black Block2 drawers and Strip accessories, made out the same color and the same height of the ITF top edging strip.

Tutto centimetri 8: piano, lavabo e accessori. *Everything is 8 cm tall: top, wash basin and accessories.*



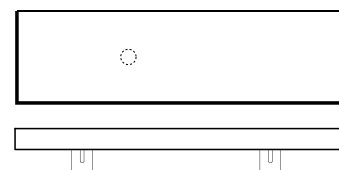

Versione top ITF cornice
bianca, piano in Prefinito
Calce beige (cod. ITFCA) e
lavabo ILA100 bianco.

*ITF top version with white
edging strip, beige Prefinito
Calce top surface (ref. ITFCA)
and ILA100 white wash basin.*



Composizione realizzata con piano ITFCA cm.200: cornice laccata bianca opaca, piano e rivestimento sopra lavabo in Prefinito Calce beige, lavabo ILA100 e contenitore in metallo su ruote IC46R verniciati bianchi, specchio filo rivestimento su misura, pensile della serie Zero20 cod. ZP290 con scocca in metallo e anta vasistas in Prefinito Calce bianca ed anta in Prefinito Calce colore rosso.



Composition made out ITFCA top 200 cm wide, white varnished edging strip, beige Prefinito Calce top surface and covering upon wash basin. White varnished cabinet on wheels IC46R and ILA100 wash basin .Customized size flush to covering mirror and Zero20 wall unit ZP290 made out metal body and white Prefinito Calce "wing" door and red Prefinito Calce door.



Dettaglio delle tre
funzioni (lavabo,
piano e contenitore)
che sottolinea la
leggerezza compositiva
dovuta all'esile
spessore della lamiera
di acciaio.

*Detail of the three
functions (wash basin,
top and cabinet)
that underlines the
matching lightness,
made possible thanks
to the thin thickness
of the metal sheet.*



**OTTONE, TRAVERTINO E CORIAN®:
CLASSICITÀ E MODERNITÀ.**

Composizione realizzata con cornice in ottone brunito, piano e alzata sopra piano in travertino (ITFM), lavabo in Corian® CLAT.P e mobili Zero20 con scocche bianche e cassetti in Prefinito Calce bianchi (ZB411C e ZB406C). Rivestimenti in Prefinito calce sabbia.

**BRASS, TRAVERTINE AND CORIAN®:
CLASSIC AND MODERN FEEL.**

Composition made out top with burnishes brass edging strip, travertine top surface and covering next to the top (ref. ITFM), Corian® wash basin and white Zero20 cabinets with white Prefinito Calce drawers (ZB411C e ZB406C). Prefinito Calce wall and floor coverings, sand color.





Composizione realizzata con piano ITFM cm.200: cornice ottone brunito, piano e rivestimento sopra lavabo in travertino (a richiesta altri marmi). Lavabo in Corian® CLAT.P con piletta in Corian. Mobili serie Zero20 con scocca bianca e cassetti in Prefinito Calce bianca (cod. ZB409C e ZB406C). Specchio filo rivestimento su misura.



Composition made out ITFM top 200 cm wide, burnished brass edging strip, travertine top surface and covering upon wash basin. Corian wash basin with Corian® drain CLAT.P. White varnished Zero20 cabinets with white Prefinito Calce drawers (ref. ZB409C and ZB406C). Customized size flush to covering mirror.





**PIANI IN LAMIERA
STIRATA (ITL)**

***EXPANDED METAL
SHEET TOP (ITL)***

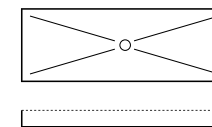
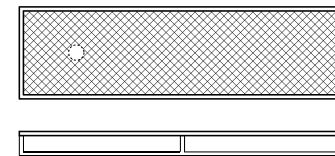

Lavabi da appoggio ILA100,
colore nero, su piano in
lamiera stirata verniciata
bianca (ITL160).

*ILA100 above inserted wash
basin, black coloured, upon
white painted expanded sheet
metal top (ITL160).*



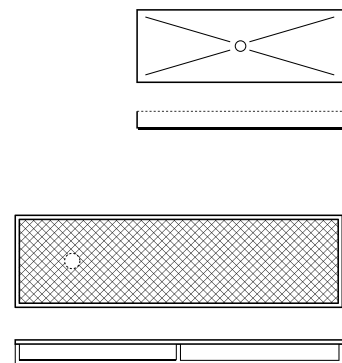

Piani in lamiera stirata ITL120 cm 120, lavabi in acciaio ILA100 ed ILA60, rivestimenti a fascia in Prefinito Cemento grigio chiaro come per le scocche delle colonne con ante di legno di recupero (B2C22R). Due cassetti cm 80 H24 serie Block2 colore nero opaco.



ITL120 expanded sheet metal tops, cm 120, steel wash basins ILA100 and ILA60, light grey Prefinito Cemento coverings. The same material for the body of tall cabinets with re-used wood doors (B2C22R). Two matt black drawers cm 80xH24, Block2 series.



Lavabo IIA60 nero su piano in lamiera stirata nera ITR120. Black IIA60 wash basin upon black ITR120 top.

Lavabo in acciaio spazzolato IIA100 su piano in lamiera stirata nera ITR120. Mensola in legno "re-used" ILAT. Brushed stainless steel IIA100 wash basin upon black ITR120 top. "Re-used" wood shelf ILAT.



LAVABI ILA ILA WASH BASIN

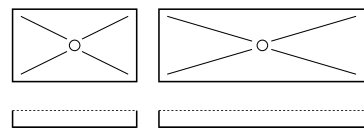

Lavabi d'appoggio
in acciaio grezzo,
spazzolato o verniciato
nei colori Moab e a
richiesta nei colori RAL.

*Above inserted wash basin
available in: unfinished or
brushed stainless steel,
standard Moab or RAL
colours upon request.*



ADI Index 2010



Lavabo da appoggio ILA100, 100x35 cm, colore turchese, su piano Block2 in Prefinito Cemento grigio chiaro.

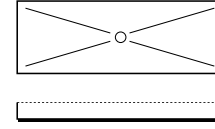

Above inserted wash basin ILA100, turquoise coloured. Light grey Prefinito Cemento top (Block2 serie).





Lavabo da appoggio ILLA100, 100x35 cm, colore turchese, su piano Block2 in Prefinito Cemento grigio chiaro.

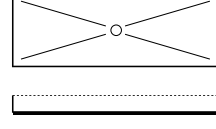

Above inserted wash basin ILLA100, turquoise coloured. Light grey Prefinito Cemento top (Block2 serie).



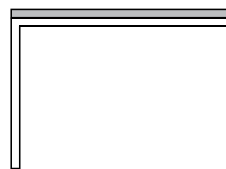
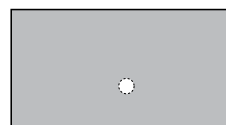
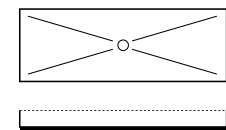

Lavabo da appoggio
ILA100, 100x35 cm,
colore turchese, su
DESK in Prefinito
Cemento testa di
moro.

*ILA100 above inserted
wash basin, 100x35cm,
turquoise coloured.
Dark brown Prefinito
Cemento DESK.*





Lavabi bianchi in
acciaio verniciato
cm 60x35 (ILA60).

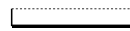
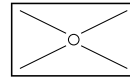

*White painted above
inserted wash basins
cm 60x35 (ILA60).*





ILA SOSPESO

Versione sospesa del lavabo di acciaio ILA, che si aggiunge a quella d'appoggio, esaltandone la leggerezza. La sospensione e lo scostamento dalla parete consentono la sovrapposizione dello specchio verticale e l'inserimento degli accessori (STRIP), della stessa altezza del lavabo. Tutto disponibile anche nei colori RAL.

SUSPENDED ILA

Suspended version of the steel ILA sink, available in addition to the above inserted version, that exalts its lightness. Its suspension and distancing from the wall allow for the application of the vertical mirror and the insertion of accessories (STRIP) at the same height as that of the sink. All available in RAL colours too.

Particolare del lavabo ILA sospeso e dello specchio verticale. Sullo sfondo piccola area di servizio realizzata con mensola - appenderia.

Detail of suspended ILA sink and vertical mirror.



Detail of the ILA100 wash basin (Industrial Line) in the suspended version with vertical mirror.

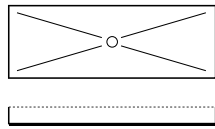

Particolare del lavabo ILA100 sospeso con specchio verticale ed asta Strip con accessori SA1 ed SA2, colore bianco.



Lavabo sottopiano ILUV
Undertop wash basin ILUV

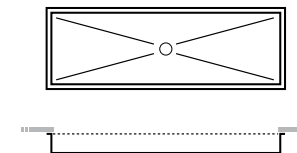

Lavabo-canale sottopiano in acciaio verniciato, particolarmente indicato per piani a profondità ridotta.
La sua forma contemporanea lo rende particolarmente compatibile ai piani della linea Block2.

*Channel shaped under-top washbasin made out with painted steel, suitable for small depth tops.
Thanks to its contemporary style It is specifically matchable with Block2 tops.*



Lavabo-canale sottopiano ILUV colore grigio sabbia, top linea Block2 in Laminato Liquido bianco. Asta porta salviette (Accessori), specchio M3, mensola porta oggetti (Complementi). Mensola su misura con appenderia (serie Block2).

Sand grey undertop channel shaped washbasin, white LL top (Block2 serie), towel bar (Accessories serie), M3 mirror and shelf. Wardrobe area made out with customised shelf with cloths hanging system (Block2 serie).



DOOR

Solido, caldo, accogliente: sono alcune delle qualità che ci inducono a scegliere il legno per l'arredamento delle nostre abitazioni, da tempo immemorabile.

La nuova collezione "DOOR" ne fa il protagonista e interpreta il massello di legno sulle sole ante con un lavoro di ebanisteria che recupera tecniche antiche, attualizzandole e contaminandole con il rigore del minimalismo contemporaneo.

Alle raffinate versioni in massello di teak, si affiancano quelle di abete usato e recuperato, con tutta la loro palese brutalità, ma non per questo meno sofisticate.

A completamento della gamma si aggiungono le nuove versioni in abete tinto colore bianco, rovere *tranchè*, Prefinito Cemento e Prefinito Calce.

I piani da abbinare sono in vetro, marmo, Corian®, legni verniciati e Prefiniti.

Solid, warm, comfortable: these are the qualities that since ancient time led us to choose wood for our home furniture.

The new collection "DOOR" embodies these concepts, applying the traditional artisan criteria of cabinet-making on solid teakwood doors to the essentiality of contemporary minimalism.

You can choose among the elegant compositions with solid teakwood doors or the sophisticated limited edition restored pinewood doors' compositions.

To complete the line, there are the brand new finishing: bleached spruce, sawn oak wood and Prefinito Calce/Cemento.

Tops and wash basins in combinations with this product line are available in glass, marble, Corian®, painted wood and Prefinito Calce/Cemento.



Door teak stripes



mobile con lavabo sottopiano
vanity cabinets for undertop sink



mobile con lavabo da appoggio
base cabinet with above insereted sink



contenitore sotto piano
undertop cabinet



Ambiente realizzato
con mobile DOOR
"teak stripes" e
top di cristallo
sabbato con lavabo
integrato; pavimenti,
rivestimenti e piatto
doccia filo pavimento
in Prefinito Cemento
colore tabacco;
specchi su misura filo
rivestimento; asta
porta-accessori e
salviette cm 180 in
acciaio spazzolato.

*Solution with DOOR
"teak stripes" with
crystal sandblasted
top; floor and wall
slabs and flush with
floor shower tray
made of tobacco
coloured Prefinito
Cemento slabs; made
to measure mirrors
flush with the wall
coverings; 180 cm
brushed steel towel
and accessories bar.*



Vanity unit with 180 cm "teak stripes" doors, top and built-in melted black sandlasted crystal sink.



Mobile con ante "teak stripes" in listellare di teak da cm 180, con piano e lavabo integrato in fusione di

cristallo nero sabbato.



Detail of the sandblasted top with integrated wash basin

Particolare del top con lavabo integrato in cristallo sabbato.



Door "teak stripes" composition with veined black marble covering top. Corian® above insert wash basin with Corian® basin drain (CLAT.P) and undertop matt ceramic wash basin (B2L3.0). Black Prefinito Calce panels on the wall and floor, customised sizes. Black Prefinito Calce shelf (BMS).



Composizione Door "teak stripes" con piano di copertura in marmo nero venato. Lavabo d'appoggio in Corian® (CLAT.P) e lavabo sottopiano in ceramica opaca (B2L3.0). A parete e a pavimento formelle su misura in Prefinito Calce colore nero. Mensola in Prefinito Calce nera (BMS).



Dettaglio del piano in marmo nero venato con lavabo sottopiano in ceramica opaca B2L3.O.

Detail of the veined black marble covering top. Matt ceramic undertop wash basin B2L3.O.





Colonne con ante "teak stripes" (B2C25L).
Tall cabinet with "teak stripes" doors (B2C25L).



Elegante ambiente realizzato con Door nella versione anta in listellare di teak.
Piano e lavabo integrato in Corian®, colonne e pedana doccia su misura.

*Elegant room obtained using Door in the version with teak stripes leaf.
Built-in Corian® top and wash basin, cabinets and made to measure shower platform.*



Composizione realizzata con rivestimenti e scocca del mobile Door in Prefinito Cemento grigio chiaro, ante in listellare di teak; lavabo in Corian® semi-incassato con piletta in Corian® a scarico libero (CL9331), realizzabile anche su misura. Accessori strip con asta in acciaio spazzolato e pensili SA10 colore rosso pomodoro, specchio su misura filo rivestimento. In abbinamento, pedana doccia in teak FTFP.

Composition made out with light grey Prefinito Cemento wall coverings, cabinet and covering top (Door serie). "Teak stripes" doors and drawers, semi built-in Corian® wash basin with Corian® free flow drain (CL9331). Wash basin available also in customized sizes. Strip accessories with brushed stainless steel bar with tomato red SA10 steel units, customized size flush to covering mirror. Customized size teak shower dais FTFP.



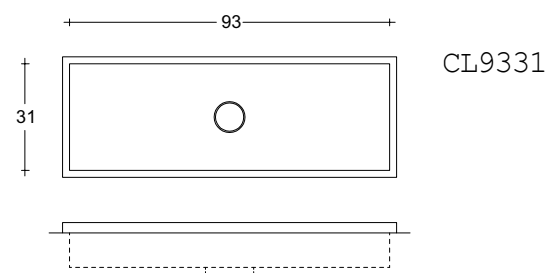
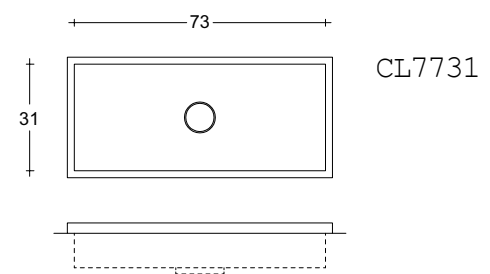
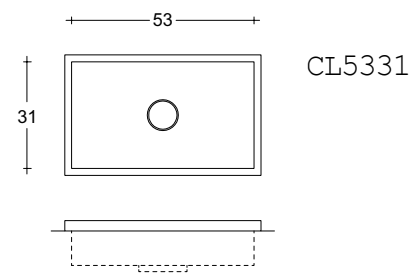

DOOR re-used

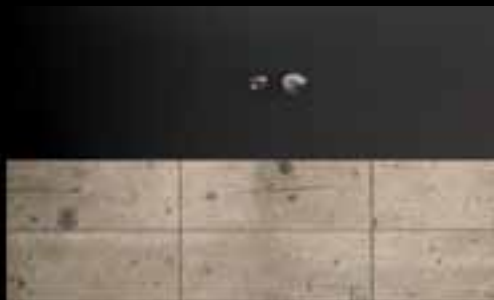

mobile con lavabo sottopiano
vanity cabinets for undertop sink



mobile con lavabo da appoggio
base cabinet with above inserted sink



contenitore sotto piano
undertop cabinet



Door versione vintage con anta "Re-Used" - *DOOR vintage version, with re-used leafs*



Mobile Door con cassetti "re-used" e cassa colore fango opaco posizionato sotto un top serie Block2 in Prefinito Calce colore fango. Sulla parete lastre su misura in Prefinito Calce colore fango, accessori Strip.

"Re-used" vanity cabinet (DOOR serie) with matt mud body. Prefinito Calce top (Block2 serie) with undertop washbasin. On the wall Prefinito Calce tiles, customised sizes. Strip bar and unit.





Door versione "re-used" proposto in abbinamento ai top a forte spessore di Block2, ai rivestimenti in Prefinito Cemento colore tabacco, agli specchi filo rivestimento e alla linea di accessori STRIP: asta in acciaio verniciato colore moka e vaschette in acciaio inox spazzolato.

Door with re-used leafs shown in combination with the Block2 tops, the tobacco-coloured Prefinito Cemento wall coverings, the mirrors mounted flush with the wall coverings and the STRIP line of accessories: moka-coloured painted steel bar and brushed stainless steel containers.

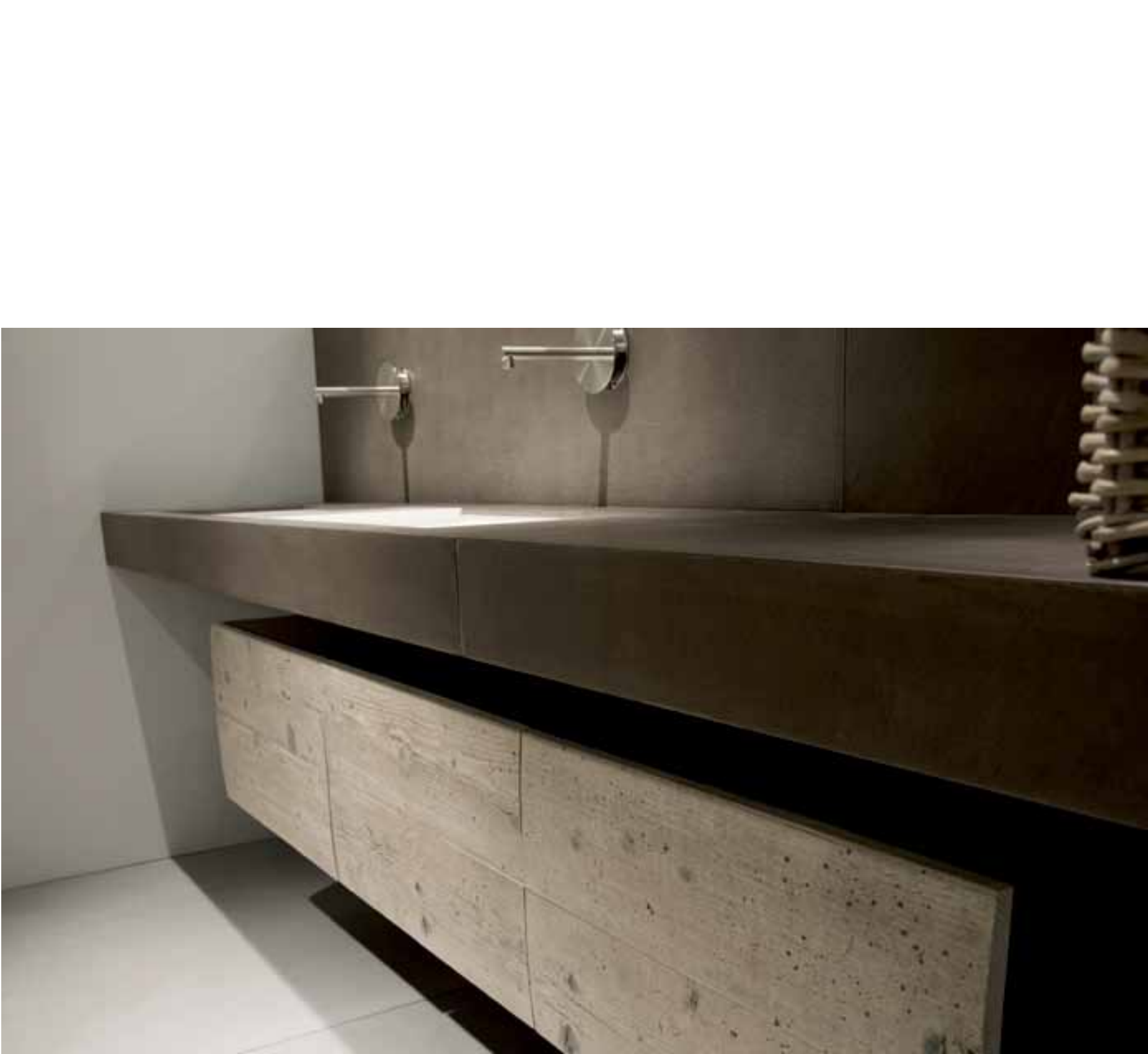



Versione di Door con scocca e rivestimenti monomaterici in Prefinito Calce nera.
In primo piano l'ampio lavabo a pozzetto in acciaio verniciato D20L.

*Door version with single-material frame and slabs in black Prefinito Calce.
In the foreground, the wide tub-shaped painted steel washbasin D20L.*



This strongly innovative proposal is completed by the handles in various shapes and materials (copper, brass, steel and Moab colours); the lopping of the leafs allows to use them also as towel rails. The spacious tub-shaped washbasin with traditional drain system and sill item No. D20L, as shown in detail, is disaligned with respect to the cabinet in terms of height and of depth.



Completano questa forte proposta innovativa le maniglie in diversi formati e finiture (rame, ottone, acciaio e colori Moab); lo svettamento dall'anta permette di utilizzarle anche come porta salviette. Il capiente lavabo a pozzetto, con scarico tradizionale e traversa ispezionabile art. D20L, come si nota nel dettaglio, è disallineato al mobile sia in altezza che in profondità.



Composition made out with black Prefinito Calce flooring, wall coverings, shelves, flush to floor shower tray and Door cabinet. "Re-used" drawers, burnished brass and copper M3 mirrors.

Composizione realizzata con pavimenti, rivestimenti, mensole a parete, piatto doccia filo pavimento e scocca del mobile Door in Prefinito Calce nera; cassette in legno re-used, specchi M3 in ottone e rame brunito.



DOOR pop

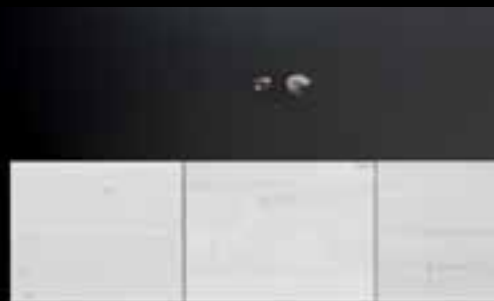

mobile con lavabo sottopiano
vanity cabinets for undertop sink



mobile con lavabo da appoggio
base cabinet with above insereted sink



contenitore sotto piano
undertop cabinet



Grafismi e materia, Pop.
Graphism and materic, Pop.



Door cabinets "pop" version, with cm 40 drawers under Block2 tops cm 160, white Prefinito Calce finishing.
Prefinito Calce large size covering panels. Mirrors and varnished steel units free mounted on two cm 90 bars (Srtip serie).

Sulla parete rivestimenti su misura in Prefinito Calce colore bianco, specchio e pensili in metallo verniciato montati liberamente su due aste cm 90 (serie Strip). Mobili Door versione "pop" con cassetti cm 40 posizionati sotto due piani serie Block2 in Prefinito Calce colore bianco cm 160.



DOOR tranché



mobile con lavabo sottopiano
vanity cabinets for undertop sink

mobile con lavabo da appoggio
base cabinet with above insereted sink

contenitore sotto piano
undertop cabinet

Versione classica di Door, rivisitata con il più contemporaneo rovere taglio sega caffè, top e lavabo integrato vetro sabbato colore nero. Pavimenti e rivestimenti in Prefinito Cemento grigio chiaro, specchio filo rivestimento su misura e accessori in acciaio spazzolato STRIP.



Classical version of Door, with the contemporary sawn oak coffee, black sandblasted glass top and integrated wash-basin. Light grey floor and wall coverings, flush to covering mirror customized size, and brushed steel accessories Strip.



Mobile Door cm 140 versione "tranché" tortora sotto un piano cm 240 serie Block2 in Prefinito Cemento grigio chiaro. Lastra asolata, piatto doccia filo pavimento e rivestimenti su misura in Prefinito Cemento colore grigio chiaro. Specchio filo rivestimento e mensola BMS in Prefinito Cemento grigio chiaro.

140 Door cabinets "tranché" version under Block2 tops cm 240, light grey Prefinito Cemento finishing, with undertop wash basin. Prefinito Cemento Flush to floor shower tray and large size covering panels on the wall and in the shower area. Flush to coverings mirror and BMS Shelf, Prefinito Cemento finishing.



BLOCK2

BLOCK2 è un programma di arredo per il bagno che prevede l'utilizzo di lavabi d'appoggio e lavabi sottopiano in combinazione con piani a forte spessore (h cm.6 / 12), mobili contenitori (h cm 24 / 48) e mobili contenitori di tutte le diverse linee di prodotto Moab. La combinazione tra piani e mobili offre ampie possibilità compositive. Disponibili due profondità: 45 e 54 cm. I piani sono in legno di rovere taglio sega caffè, tortora, beige, bianco e naturale, in Corian®, solid surface oppure laccati con vernici resistenti all'acqua e al graffio denominate L.L., disponibili nei colori Moab oppure a richiesta Ral/NCS, oppure in Prefinito Cemento e Calce in vari colori coordinati ai piatti doccia filo pavimento e ai rivestimenti. Piani e mobili sono compatibili con i lavabi della serie "Industrial Line".

BLOCK2 is a bathroom furniture program consisting with indertop and above inserted wash basins in combination with hick shelving system (h cm 6 / 12) and base cabinets (h cm 24 / 48) and all other moab product series. The combination between tops and cabinets provides a wide rage of possible composition. Two deep dimension available: 45 and 45 cm. Tops are available in sawn oak coffe, gray beige, white and natural, Corian®, solid surface, wather and scrub resistance laquered colors available in Moab colors or upon reques Ral/NCS, or in Prefinito Cemento / Calce in various colours matching the flush to floor shower trays. Tops and base cabinets are compatible with "Industrial Line" wash basins.





Composizione realizzata con top cm 200 laccato bianco LL, lavabi sottopiano in ceramica B2L3, mensola sottolavabo cm. 200 laccata bianco LL, specchio filo lucido cm 200.

Composition made with top 200 cm LL white, ceramic undertop sinks B2L3, under-basin shelf 200 cm, LL white, mirror 200 cm.



Composizione
realizzata con top
sospeso in Prefinito
Cemento colore grigio
chiaro, doppio
lavabo, cm 240
totali, profondità
54 cm (B2S58).
Lavabi sottopiano in
Corian® con scarico
a scomparsa B2L1 e
traversa in Corian®
B2LT, contenitori con
anta senza maniglia
bianco LL (B2B56M)
cm 60, specchio filo
lucido BS240 cm 240,
lampade alogene
BLL. Rivestimenti in
Prefinito Cemento a
parete e a pavimento
su misura grigio
chiaro (RM1022).

*Composition made with
light grey Prefinito
Cemento suspended top
240 cm, 54 cm deep
(B2S58), with Corian®
undertop-double wash
basin with hidden
drain system and
Corian® bridge-shelf
B2LT, 60 cm base
cabinets with door
and without handle
(B2B56M) LL white,
240 cm bevelled
mirror BS240, halogen
lamp BLL. Customized
wall and Prefinito
Cemento floor covering
panels, light grey
colour (RM1022).*





Composizione realizzata con top
cm 180 profondità 45 cm (B2S48),
Prefinito Cemento colore grigio
chiaro, lavabo canale sottopiano
in acciaio verniciato bianco (ILUV)
serie Industrial Line, contenitori
con cassetti rovere taglio sega caffè.
Rivestimenti a parete su misura in
Prefinito Cemento colore grigio charo
con specchio filo rivestimento.

*Composition made with light grey
Prefinito Cemento top 180 cm, 45 cm
deep (B2S48), painted steel channel
shaped undertop wash basin (ILUV),
Industrial Line serie. Sawn oak coffe
drawers. Light grey Prefinito Cemento
wall coverings, customized size, with
flush to covering mirror.*



Ambiente realizzato con rivestimenti in grande formato e top in Prefinito Calce fango su misura, due lavabi sottopiano in ceramica, specchio filo rivestimento, ampi contenitori sottolavabo in bianco opaco, art. B2B58M.

Room made out Prefinito Calce large size coverings and top in customised size, mud colour. Two undertop ceramic wash-basins and flush to covering mirror. Large matt white under-top cabinet, ref. B2B58M.





Composizione realizzata con piano di Block2 art.B2S48, un lavabo in ceramica opaca art. B2L3.0, sei contenitori cm 60 con unico piano di copertura art. B2T45, specchio filo lucido art. BS180, contenitore in acciaio art. IC46 colore rosso pomodoro. In abbinamento alla composizione della zona acqua, due colonne art B2C26A in legno tranché colore caffè.

Composition made out Block2 top B2S48, undertop matt ceramic wash-basin ref. B2L3.0, six cabinets cm 60 width B2T45 covering top. Bevelled edge mirror ref. BS180. Painted aluminium wall mounting cabinet, tomato red coloured. In front of the water area, two coffee sawn oak tall cabinets ref. B2C26A.





Piano e rivestimenti in Prefinito Calce bianca, cassetti in rovere tranché colore tortora.
I volumi sono alleggeriti dal contenitore in acciaio con vani a giorno Art. IC46 colore rosso pomodoro.

Top and slabs in white Prefinito Calce, drawers in tranché turtle-dove coloured oak. The volumes are made lighter by the tomato red steel container with open spaces item No.IC46.





Top in Prefinito Calce colore bianco B2S48 con lavabo in ceramica opaca B2L3.0 ed accessorio porta salviette in ottone brunito (disponibile anche in altre misure e finiture). Completano l'arredo due mobili Zero20 con scocca in lamiera colore nero e ante in vetro industriale retinato (ZB409A). Strip porta salviette e accessori.



Block2 Prefinito Calce top B2S48 with matt ceramic wash basin B2L3.0 and burnished brass towel holder (available also in other finishings and dimensions). Black aluminium Zero20 cabinets with industrial wired glass doors (ZB409A). Strip bar: towel and accessories holder.



Ambientazione realizzata con piano in Corian® e lavabo integrato, cassetti h 24 della serie Block2 laccati, rivestimenti e pavimenti in Prefinito Calce beige con pedana doccia su misura in listellare di teak.

Composition made out with Corian® top and melted washbasin, matt white painted h 24 draw unit, beige Prefinito Calce wall and floor panels, solid teak stripes flush to floor shower tray.



Top della serie Block2 H14 in Corian® con lavabo integrato CL6532. Cassettiera su ruote in lamiera verniciata bianca IC46R della linea Industrial Line.

Block2 H14 Corian® top with integrated wash basin CL6532. White painted aluminium cabinet on wheels IC46R (Industrial Line series).

CL4530

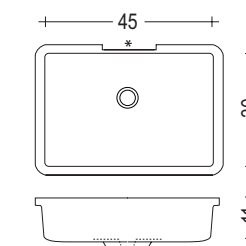

CL5532

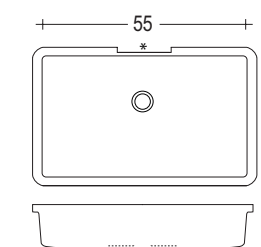

CL6535

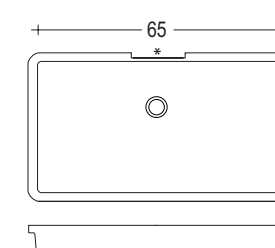



Top in Corian® bianco con doppio lavabo B2L1 con scarico a scomparsa. Cassettiere su ruote BR6 in rovere taglio sega colore tortora.



White Corian® top with two B2L1 wash basins with hidden drain system. Sawn oak grey beige cabinets on wheels (art. BR6).



Top in Corian® colore bianco doppio lavabo con scarico a scomparsa e mobile bianco della linea Zero20 con cassetto in Prefinito Calce bianca (art. ZB411C).

White Corian® top with two B2L1 wash basins with hidden drain system and white Zero20 cabinet with white Prefinito Calce drawer (art. ZB411C).





Ambiente realizzato con top B2S48 della serie Block2 in Corian® h 14 con lavabo integrato di ampie dimensioni (art. CL6535), contenitore Zero20 bianco (art. ZB411A) con ante in rovere tranché tortora. Sulla parete opposta, pensili ZP267 e ZP290 neri con ante in Prefinito Cemento, Prefinito Calce e rovere tranché. Sullo sfondo, ambiente doccia realizzato con piatto doccia in Corian® su misura, asta porta accessori Strip in lamiera di acciaio verniciata e sgabello Nino (serie Accessori).

Room with B2S48 Block2 Corian® top H14 cm with wide integrated wash basin (art. CL6535), white Zero20 cabinet (art. ZB411A) with sawn oak grey beige doors. On the opposite wall: ZP267 and ZP290 black units with doors in many finishing: sawn oak grey beige, sand Prefinito Cemento and mud Prefinito Calce. In the background: shower area with customized Corian® wash basin, painted steel Strip bar with holders and Nino stool (Accessori series).



Primo piano del top B2S48 con lavabo integrato in Corian®, mobile Zero20 con ante in rovere tranché tortora, accessori serie Strip.

Detail of the Corian® top B2S48 with integrated wash basin, Zero20 cabinet with sawn oak grey beige doors. Strip bar with accessories.

Pensili ZP267 e ZP290 neri con ante in Prefinito Cemento, Prefinito Calce e rovere tranché colore tortora.

ZP267 and ZP290 black units with doors in many finishing: sawn oak grey beige, sand Prefinito Cemento and mud Prefinito Calce.





Composizione realizzata da top 180 cm profondità 45 laccata bianco Laminato Liquido (B2S48) con lavabo sottopiano in ceramica (B2L3.L). Mensole sottolavabo su misura (B2A648) laccate bianco LL. Colonne (B2C22C) amaranto opaco e lampone lucido. Specchi M3 bianchi opachi.

Composition made with white LL suspended top 180 cm 45 cm deep (B2S48) with ceramic undertop sink (B2L3.L). White LL undertop shelf with measure on demand (B2A648). Matt amaranth and gloss raspberry columns (B2C22C). Matt white M3 mirrors.



Composizione realizzata con top cm 220, profondità 54 cm (B2S58), bianco laccato LL, lavabo sottopiano in Corian® con scarico tradizionale B2L2, contenitori con cassetti B2B54C cm 40 finitura bianco LL, specchio filo lucido PSC.

Composition made with top 220 cm, 45 cm deep (B2S58), LL white, Corian® undertop sink with traditional drain system B2L2, 40 cm base cabinets B2B54C LL white, 220 x h 45 cm bevelled mirror PSC.





Composizione realizzata con top cm 180
profondità 54 cm (B2S58) laccato bianco LL,
lavabo sottopiano in ceramica con scarico
tradizionale B2L3.L, specchio filo lucido PSC
cm 180x h 45, lampada BLL, basi con anta senza
maniglia apertura a pressione B2B56M e piano di
copertura B2T54 laccate bianco LL.

*Composition made with top 180 cm, 45 cm deep
(B2S58) LL white, ceramic undertop sink with
traditional drain system B2L3.L, bevelled mirror
PSC 180xh45 cm, lamp BLL, base cabinets with
door without handle B2B56M and covering top
B2T54 LL white.*



Composizione
realizzata con top
sospeso doppio
lavabo in rovere
taglio sega colore
caffè cm 240,
profondità 54
(B2S58), lavabi
sottopiano con
scarico a scomparsa
B2L1 e traversa
in Corian®(B2LT),
contenitori cm
60 con cassette
(B2B56C) e piano di
coperura (B2T54)
rovere taglio sega
caffè, specchio
filo lucido cm 180
(BSL), pensili
cm 60 (B2P16A),
lampade alogene
BLL. Rivestimenti a
parete e pavimento
su misura in
Prefinito Cemento
grigio chiaro
(RM1022).





Composition
made with
suspended top
240x54 cm for
undertop-double
sink sawn oak
coffe (B2S58),
Corian®
undertop
sinks with
hidden drain
system and
bridge-shelf
(B2LT), 60 cm
base cabinet
(B2B56C) with
drawers and
covering top
(B2T54) sawn
oak coffee.
Bevelled mirror
cm 180 (BSL),
60 cm wall unit
wengè (B2P16A),
halogen lamp
BLL. Light
grey Prefinito
Cemento wall
and floor
covering panels
(RM1022).





Composizione realizzata con top sospeso rovere taglio sega caffè cm 200, profondità 54 cm (B2S58), lavabo sottopiano in Corian® con scarico tradizionale B2L2, contenitori B2B58M con antasenza maniglia cm 60 apertura a pressione, piano di copertura B2T54, specchio filo lucido PSC cm 200, pensili rovere taglio sega caffè B2P14A cm 40, lampada alogena BLL, asta porta salviette in acciaio. Rivestimenti a parete e pavimento su misura Prefinito Cemento grigio chiaro (RM1022).

Composition made with suspended top 200x54 cm sawn oak coffee B2S58, Corian® undertop sink with traditional drain system B2L2, 60 cm base cabinet with door without handle B2B58M, B2T54 covering top and 200 cm bevelled mirror PSC. 40 cm wall units B2P14A, halogen lamp BLL, 120 cm towel bar. Grey Prefinito Cemento wall and floor covering panels.





Composizione realizzata con top (B2S48) in rovere finitura taglio sega colore beige 140 cm, profondità 45 cm con lavabo sottopiano in ceramica B2L3.L.
Mensole bianche lucide con attacchi a scomparsa cm 120x15 (BMS). Colonne senza maniglia colori amaranto opaco, lampone opaco e rosso rubino lucido (B2C22C).

*Composizion made with 140x45 cm sawn oak beige top (B2S48) with undertop ceramic sink (B2L3.L).
Gloss white shelves 120x15 with hidden fittings (BMS).
Matt amaranth, matt raspberry and gloss ruby red columns without handle (B2C22C).*





Composizione realizzata con top sospeso prof. 45 rovere taglio sega caffè B2S48 cm 180, contenitore con cassetti B2B48C cm 80, piano di copertura B2T45, lavabo da appoggio ceramica lucida SLC.L, specchio filo lucido cm 260 h. cm 60.

Composition made with suspended top 180 cm sawn oak coffee B2S48, 80 cm base cabinet B2B48C, B2T45 covering top, gloss ceramic above inserted sink SLC.L, bevelled mirror 260 cm,h 60 cm.





Composizione rovere taglio
sega caffè realizzata con
top sospeso prof. 45 cod.
B2S48 cm 180, contenitore
con cassetti B2B48C cm
80 e piano di copertura
B2T48. Lavabo da appoggio
ceramica lucida SLC.L,
specchio filo lucido cm 260
h. cm 60.

*Composition made with
suspended top 180 cm
B2S48, 80 cm base cabinet
B2B48C with B2T48 covering
top sawn oak coffee. Gloss
ceramic above inserted
sink SLC.L, bevelled
mirror 260 cm,h 60 cm.*



Composizione realizzata da top 160 cm rofondità 45 cm beige L.L. (B2S48) con lavabo da appoggio in ceramica (B2LC).

Due cassette contenitori cm 80 colore tortora lucido (B3B48C) e piano di copertura (B2T45) con asola per sifone (AS). Rivestimenti in formelle Prefinito Cemento panna formato 120x40.

Composition made with 160x45 cm L.L. beige top (B2S48) with ceramic above inserted sink (B2LC), two cabinets (B3B48C) cm 80 gloss grey beige and covering top (B2T45) with slot for siphon (AS). 40x120 cm milk white Prefinito Cemento covering panels.



Variante con un unico cassetto contenitore cm 80 colore tortora lucido (B3B48C) e piano di copertura (B2T45).

Variant with only one cabinet (B3B48C) cm 80 gloss grey beige and covering top (B2T45).





Composizione
realizzata con Top
in Prefinito Cemento
160 profondità 45 cm
colore panna (B2S48)
con doppio lavabo
in ceramica lucida
SLC.L, 2 cassette
cm 60 (B3B46C),
un contenitore cm
40 (B3B44C) rosso
rubino opaco, piano
di copertura B2T45
con due asole per per
sifone (AS).
Specchio 160x60
(ES160) con due
lampade alogene BLL,
4 formelle in Prefinito
Cemento colore panna
formato 120x40.

*Composition made with
160x45 cm milk white
Prefinito Cemento top
(B2S48) with two above
inserted ceramic sinks
(SLC.L). Two 60 cm
cabinets (B3B46C),
one cm 40 cabinet
(B3C44C) matt ruby red
and B2T45 covering top
with two slots for
siphon (AS).
160X60 mirror (ES160)
with two BLL lamps,
four 40x120 cm milk
white Prefinito Cemento
covering panels.*





Composizione da 160 cm formata da 3 contenitori moka opaco (B3B44C) e piano di copertura (B2T45) con foro per lavabo d'appoggio (AL), un contenitore rovere taglio sega colore tortora (B3B44C) con piano di copertura (B2T45) senza fori. Lavabo in *solid surface* da appoggio (T20L), specchio 60x60 cm (ES60), lampada BLL.

160 cm composition made with 3 matt moka cabinet (B3B44C) with covering top (B2T45) with cutout for wash basin (AL), one sawn oak gray beige cabinet (B3B44C) and covering top without hole. White solid surface sink (T20L), 60x60 cm mirror (ES60), BLL lamp.





Glossy amaranth composition 180x45 cm made with three 60 cm vanity units (B2B46M) without handles and B2T45 grey extra glass top with ceramic above inserted sink B2LC. Two glossy amaranth shelves with hidden fittings (BMS), mirror SSV 40x120 cm, halogen lamp BLL.

Mobile cm 180
profondità 45,
colore amaranth
lucido, formato
da tre contenitori
senza maniglie cm
60 (B2B46M) con
top di copertura
(B2T45) in
cristallo smaltato
grigio chiaro
su extrachiaro.
Lavabo da appoggio
in ceramica
B2LC, due mensole
con attacchi a
scomparsa amaranth
lucido, specchio
SSV cm 40x120,
lampada BLL.





Composizione realizzata con mobile con cassette B2B48C e piano di copertura B2T45 largo cm 80, profondità cm 45, in rovere taglio sega colore caffè. Lavabo B2BL4 in Corian® da appoggio con scarico tradizionale, specchio filo lucido verticale cm 45 x h100, piatto doccia filo pavimento cm 80x80 in Corian®.

Composition made with 80 cm wide and 45 cm deep wash basin holding base sawn oak coffee B2B48C with B2T45 covering top. Corian® above inserted sink with traditional drain system, vertical bevelled mirror 45 cm, flush to floor shower tray in Corian® 80x80 cm.



Composizione profondità 45 realizzata con tre contenitori cm 60 con anta senza maniglie rovere taglio sega caffè (B2B46M), piano di copertura B2T45 cm 180 e alzata B2TA4 in cristallo smaltato grigio perla (colore a richiesta), lavabo da appoggio in ceramica SLC, specchio filo lucido cm 180, mensole BMS.

Composition 45 cm deep made with three 60 cm cabinets sawn oak coffee with doors and without handle (B2B46M), covering top 180 cm (B2T45) and grey enamelled glass splash B2TA4. Ceramic above inserted sink SLC, 180 cm bevelled mirror, and BMS shelves.





45 cm deep composition made with 60 cm wash basin holding base B2B46M and B2T45 covering top sawn oak natural cm 240. Ceramic above inserted sink SLC. Mirror PSC cm 240xh45.

Composizione profondità cm 45 realizzata con quattro basi B2B46M cm 60 e piano di copertura B2T45 in rovere taglio sega naturale con lavabo da appoggio in ceramica SLC. Specchio PSC cm. 240 h. cm 45.





Mobile colore moka opaco cm 160, profondità cm 45 composto da due basi B2B48M cm 80, piano di copertura B2T45 con lavabo integrato monofusione in vetro acidato colore moka e lavabo integrato (LIC) con vasca lucida.

Matt very dark brown composition 160x45 cm made out with: two units 80 cm each without handles ref. B2B48M and acid etched glass top ref. B2T45 with melted glossy wash basin (ref. LIC).



Mobile nero lucido senza maniglie formato da una base portalavabo cm 80 (B2B58M) ed una base cm 40 (B2B54M). Piano di copertura B2T54 con lavabo integrato monofusione in cristallo extrachiaro (LIC) smaltato colore beige. Specchio 60x60 (ES60) con lampada BLL, mensole nere lucide larghezza 100 cm (BMS), 2 pensili bianco lucido (BQ1 serie Block), asta in acciaio inox spazzolato cm 100 (BA38).

Glossy black composition made with 80 cm cabinet (B2B58M), 40 cm base cabinet (B2B54M). Beige extra glass top with melted sink (LIC). 60x60cm mirror (ES60), halogen lamp BLL, 100 cm glossy black shelves (BMS), two glossy white wall units (BQ1 from Block Series), 100 cm bar (BA38).



Mobile rosso rubino opaco larghezza 140 cm profondità 45 cm, formato da base con cassetti larghezza 80 cm (B2B48C) e contenitore larghezza 60 cm (B2B46C). Piano di copertura (B2T45) con lavabo integrato monofusione in cristallo smaltato extrachiaro rosso rubino (LIC).

Matt ruby red composition 160x45 cm, made out with cm 80 base cabinet (B2B48C) and cm 60 base cabinet (B2B46C). Ruby red extra glass top (B2T45) with integrated sink (LIC).





Mobile cm 160, profondità 45 cm in rovere taglio sega naturale, formato da una base con anta cm 40 (B2B44M), una base cm 80 con ante (B2B48M), una base due cassetti cm 40 (B2B44C) e top di copertura cm 160 (B2T45).
Pensile rovere taglio sega caffè (B2P84A), due mensole bianco lucido (BMS).

Sawn oak natural composition 160x45 cm made with 40 cm base cabinet with door (B4B44M), 80 cm vanity unit with doors (B2B48M), 40 cm base cabinet with door (B2B44C) and 160 cm covering top (B2T45). Sawn oak coffee wall unit (B2P84A), two glossy white shelves (BMS).





Composizione
realizzata con due
basi cm 80 B2B48C
colore moka opaco,
piano di copertura
(B2T45) in pietra
serena cm 160 con
lavabo sottopiano
B2L3.L in ceramica
lucida, specchio
BS160 cm 160x80h
con lampada alogena
BLL.

*Composition made
with two matt moka
cabinets (B2B48C)
and covering top
(B2T45) tuscan stone
cm 160, undertop
ceramic sink
B2L3.L, bevelled
edge mirror BS160
cm 160x80h with BLL
halogen lamp.*



Minimali ed eleganti piani sospesi in marmo, massello di legno e varie finiture. Pratici ed essenziali contenitori con cassetti estraibili fanno di Block il mobile ideale per un ambiente che si caratterizza per la semplicità estetica e la purezza formale.

Minimal and elegant suspended tops in marble, solid wood and various finishings. Functional and essential drawer cabinets system, makes Block the ideal answer aesthetic simplicity, formal pureness, low profile environments.

block



Programma di arredamento composto da elementi contenitori componibili con cassetti estraibili e top da appoggio, oppure da piani sospesi e contenitori su ruote. Attraverso la combinazione delle basi porta-lavabo e delle basi laterali si possono ottenere numerose composizioni che assecondano le diverse esigenze dimensionali.

Block is a furnishing program for bathrooms which is made up for modular storage cabinets and vanity tops, or of wall-mounted tops and cabinet on wheels. By combining the vanity cabinets and side cabinets a great number of composition can be obtained, thereby meeting all dimensional requirements.





Composizione realizzata con mobile colore grigio scuro opaco da cm 180 formato da due basi porta-lavabo BP6 e da una base BB6, top in rovere taglio sega naturale BT2 180, lavabi sottopiano in ceramica BL4 e specchio BS180. Asta portasalviette BA3.

Composition made with base cabinets dark grey matt 180 cm combining 2 wash basin elements BP6, 1BB6 base element, saw mark finish natural oak BT2180 top, two undertops ceramic sinks BL1, mirror BS180, BA3 towel bar.



Composizione
realizzata con due
mobili colore bianco
opaco da cm 120
formati da una base
porta-lavabo BP6
e da tre basi BB6,
due top in marmo
cristallino BT120,
lavabo in ceramica
BL4 e due aste
portasalviette BA1.

*Composition made out
with 2 base cabinets
120 cm matt white
colour combining
1 BP6 wash basin
element plus 3 base
cabinets BB6, two
crystal marble BT120
tops, BL4 ceramic
sinks, 2 BA1 towel
bars.*





Composizione
realizzata con
mobile colore
grigio scuro cm
180 formato da
una base porta-
lavabo BP6 e da
due basi BB6,
top in marmo
biancone BT180,
lavabo BL4,
specchio ES120,
lampada alogena
BLL.

*Composition
made with
base cabinets
180 cm dark
grey finished
combining 1
BP6 wash basin
plus 2 BB6
base cabinets,
biancone marble
BT180 top, BL4
sink, mirror
ES120, BLL
halogene light.*



twin



P 40

Miniserie composta dal mobile portalavabo, personalizzabile attraverso la scelta di numerose essenze di legno e laccature, in combinazione con il lavabo in *solid surface* bianco e piano da appoggio in vetro, in vari colori e finiture, con foro portasalviette. Dimensioni minime ideali anche per piccoli ambienti per proporzioni e misure.

Mini-series composed of a vanity unit, available in matt, gloss and LL painting, or wooden finishings in combination with a white solid surface sink and glass top with hole for towel. Small size units are particularly recommended for small area.

Mobile P40 in rovere taglio sega colore tortora, ripiano in cristallo fumè con foro porta-salviette, lavabo in *solid surface* con piano copri piletta. Rivestimento su misura in Prefinito Cemento colore grigio chiaro.

Sawn oak gray beige P40 unit, smoky glass top with hole for the towel, white solid surface sink equipped with covering top. Light gray Prefinito Cemento wall covering panel.



piano removibile
copri piletta
covering
top

Mobili P40 in rovere taglio sega colore caffè e naturale, ripiani in cristallo fumè con foro porta-salviette, lavabo bianco in *solid surface* con piano copri piletta. Rivestimento su misura in Prefinito Cemento colore grigio chiaro. Specchi M3 colore grigio scuro.

Sawn oak coffee and natural P40 units, smoky glass tops with holes for the towel, white solid surface sinks equipped with covering tops. Light grey Prefinito Cemento wall covering panels.

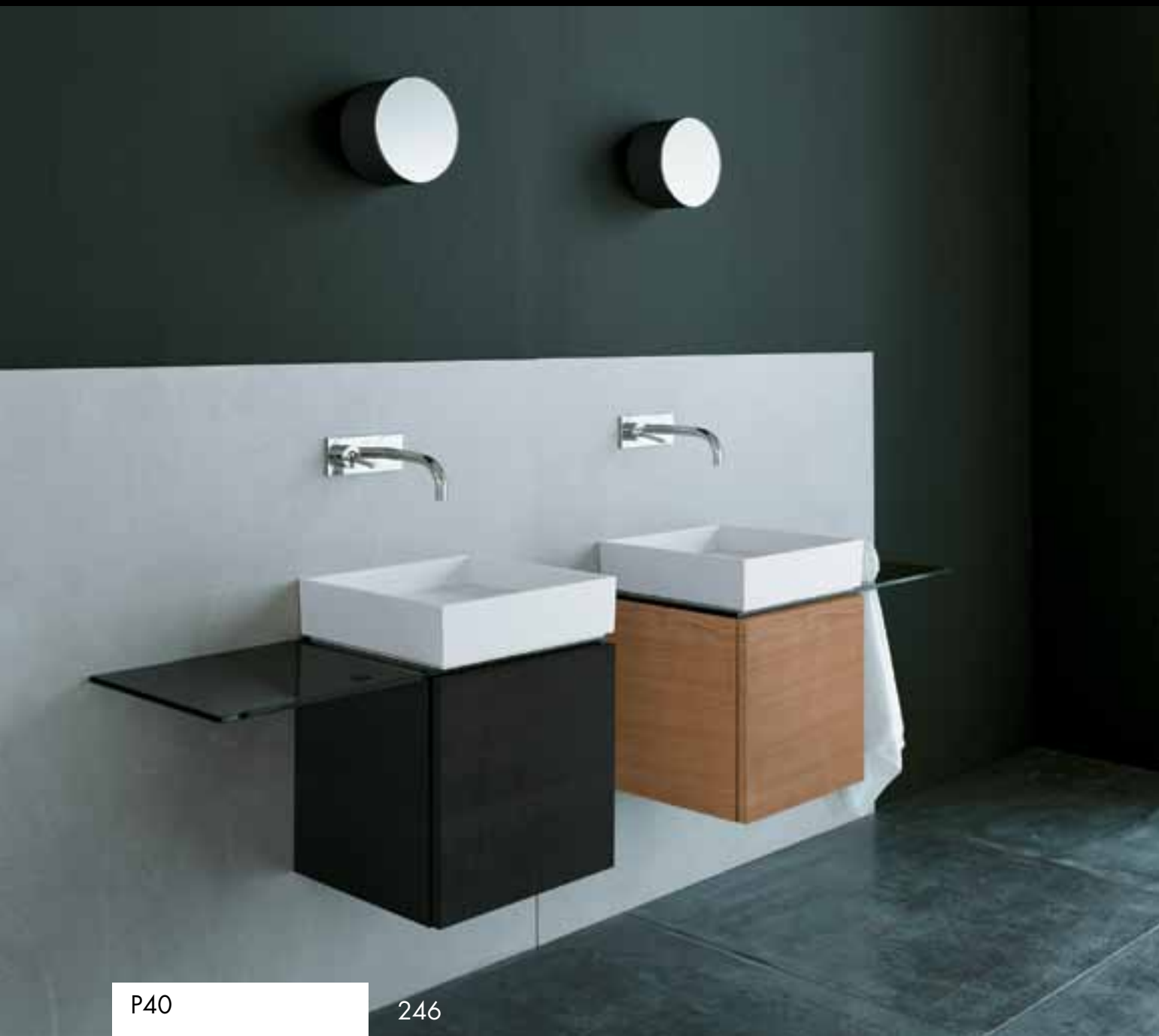



shelf

Sistema di mobili-mensola dalle geometrie primarie, non statiche e ampliabili, a configurazioni multiple, simmetrico e asimmetrico, pensato per ospitare lavabi da appoggio. Disponibile laccato in diversi colori o in essenza di legno. Il sistema è a dimensione variabile, con passo cm 10, da un minimo di 80 a un massimo di cm 180.

Multiple system of tops, symmetric or asymmetric, for above mounted sinks available in wood or LL paint in several colours. This system is flexible in size, every 10 cm starting from a minimum of 80 cm up to maximum 180 cm.

Composizione realizzata con mobile colore rosso L.L. cm 180 art. SMB, specchio filo lucido SFL.
Composition made with vanity open base L.L. red finish ref. SMB, bevelled mirror SFL.

Composizione realizzata
con mobile in rovere
taglio sega naturale.
articolo SMB, specchio
filo lucido SFL.

*Composition made
with vanity open base
sawn oak natural SMB,
bevelled mirror SFL.*





Composizione realizzata con mobile asimmetrico bianco L.L. art. SMB, lavabo in ceramica SLC, contenitore bianco L.L.SC, specchio verticale SSV.

Composition made with asymmetric vanity open base L.L. white finish SMB, free-standing white ceramic sink SLC, L.L. white unit SC, vertical mirror SSV.





Composizione cm 180
realizzata con mobile
asimmetrico grigio
L.L. (cod.SMB).
Rivestimento pareti,
pavimento e piatto
doccia filo pavimento
cm 80x80 in Prefinito
Cemento rosso.

*Composition made with
cm 180 asymmetric
vanity open base L.L.
Floor built-in shower
tray 80x80 cm and
slab coverings red
Prefinito Cemento.*





Composizione
realizzata con
mobili in rovere
taglio sega
caffè art. SMB,
contenitore SC,
specchi SFL.
Piatto doccia
filo pavimento
cm 80x80 (FP880)
in Prefinito
Cemento grigio
chiaro.

*Composition
made with in
Sawn oak coffe
vanity open
base SMB, unit
SC, bevelled
mirrors SFL.
Floor built-
in shower
trays 80x80 cm
(FP880)
in light grey
Prefinito
Cemento.*



linea

Concept: Studio Moab
Design: Salvagni Architetti
Brevetto n°RM2004A000184

Il progetto Linea è un sistema di arredo per la stanza da bagno che propone il piano, il lavabo con scarico a scomparsa e il sistema di erogazione dell'acqua con l'eliminazione visiva del rubinetto.

L'innovazione sta nel fornire un unico elemento con tali funzioni integrate.

Il risultato è un complemento di arredo dal segno forte, che passa dalla superficie al volume, non identificabile nella sua funzione primaria, collocabile ovunque, anche fuori della stanza da bagno.

Linea is a furniture program for bathroom combining: vanity top and integrated wash-basin with concealed drain system and the visual exclusion of the tap. The innovation is to supply all together integrated in one element. The great aesthetical impact of this product that turns surface into volume, make it, far from its primary use, an original proposal of furniture in itself, even outside the bathroom.

Anteprima / Salone internazionale del Mobile / Milano 2004

Il piano lavabo
Linea viene proposto
in un contesto
diverso dalla stanza
da bagno, grazie
alla eliminazione
visiva del rubinetto
che ne connota la
funzione.

*The wash-basin
"Linea" is proposed
in a different
interior than
the traditional
bathroom, thanks to
the hidden tap that
focus its function.*





Linea è un programma modulare formato dal lavabo cm 110x57 in Corian® bianco, completo di top e impianto di erogazione acqua e scarico a scomparsa, e cassette da porre lateralmente al lavabo da cm 40 e 60. Il piano in Corian® bianco, entro certi limiti, viene fornito in un unico pezzo; la scocca e i frontali sono disponibili in essenza e nei colori in gamma lucidi e opachi.

Linea is a modular line comprising a cm 110x57 wash basin made of white Corian®, complete with top integrating the hydraulic system featuring concealed drain and spout, plus cm 40 and 60 drawers to be placed on one side of the sink.

The white Corian® top, within certain size limits, is supplied in a single piece. The support and front panels are available in wood or matt and gloss colours.



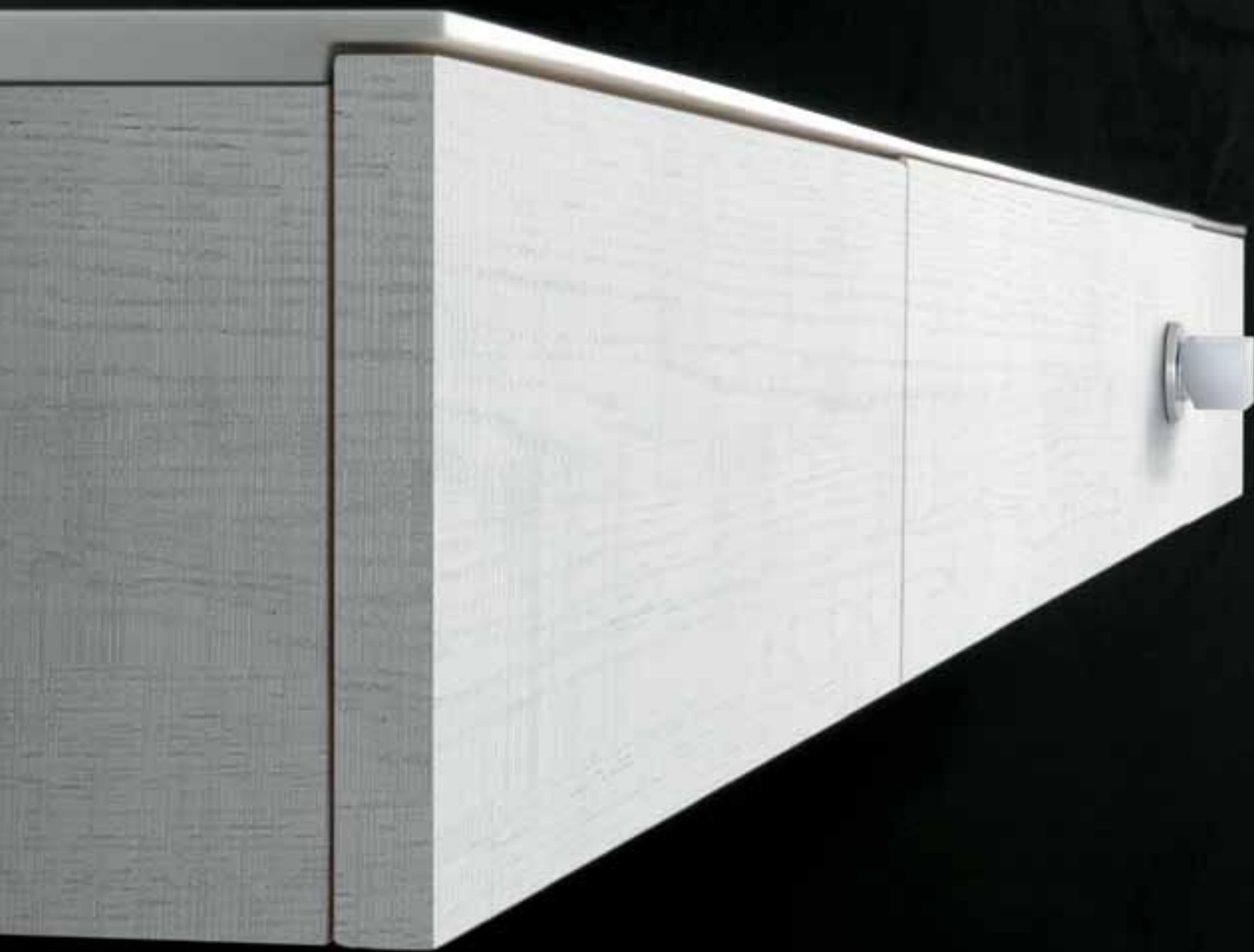

Composizione Linea 150x57 cm, costituita da lavabo completo di top ed impianto di erogazione acqua e scarico a scomparsa in Corian® Bianco con struttura e frontale in rovere taglio sega bianco e cassetto a sinistra cm 40 con top in Corian® integrato con il lavabo.

Composition of Linea 150x57 cm, consisting of wash basin complete with white Corian® top integrating the hydraulic system featuring concealed drain and spout, mounted on a support and front panels made of sawn oak white and cm 40 left drawer with Corian® top seamlessly joined to the wash basin.



A.I.S. All Inclusive Sink



AIS sfrutta la tecnologia brevettata nel 2004, con grande anticipazione delle tendenze successive, che prevede l'erogazione a lama d'acqua, a scomparsa, in un'ottica di decontestualizzazione dell'oggetto. Offre quindi anche la possibilità di collocare un lavabo fuori dal bagno eliminando il particolare che più lo connota come tale: il rubinetto. Corian® bianco. A richiesta altri colori reperibili.

AIS takes its source from the technology patented in 2004, anticipating the future coming trends, of the hidden water sheet supplying, in a vision of decontextualization of the object. AIS gives the chance to place the sink even out the bathroom eliminating the tap as main feature of the bathroom area. White Corian®. Upon request additional colours are available.



I CEMENTI DI MOAB

Il Cemento è materia dalle grandi potenzialità formali, forza innovatrice e dall'aspetto povero. In questi ultimi anni ha conquistato un posto d'onore nella progettazione d'interni e acquisito un valore aggiunto altamente estetico. Ha in sé un contenuto culturale che lo ha fatto diventare una pietra preziosa che seleziona estimatori poiché esprime e rappresenta il lusso sotto forma di understatement. Quasi un'icona dello stile informale, il cemento, grazie alla sua identità non convenzionale, è materia ideale per ambienti di stile contemporaneo *degagè*. Sapientemente manipolata a scopo interior è capace di creare ambienti unitari e raffinati.

Con questo spirito nasce lo studio di prodotti in cemento capaci di interpretare tali concetti in modo semi-industriale e dare l'opportunità a coloro che amano l'estetica non convenzionale di realizzare un ambiente ideale con facilità.

Espressione tangibile di tale ricerca sono i lavabi ELLE, ELLEDUE ed ELLETRE realizzati in composti cementizi tramite stampaggio e la gamma di PREFINITI per rivestimenti, pavimenti, piatti doccia filo pavimento e piani della linea Block2, rivestiti in Prefinito Cemento, una malta di quarzo, cemento e resina (vedi pag. 316).

MOAB CEMENT

Cement is a material featuring outstanding formal properties that gives it great innovative strength despite its understated appearance.

*In these last few years, cement has taken center stage in interior design projects and has acquired highly aesthetic added value. Its cultural content has revealed it as a precious stone that reaps admirers attracted by its capacity to express luxury as an understatement. Almost an icon of informal style, thanks to its non-conventional identity cement is the ideal material for *degagè* contemporary style decorating. Skillfully manipulated for interior design purposes, it creates unitary and refined environments.*

*This is the spirit behind our research on cement products capable of interpreting these aesthetic concepts in a semi-industrial way, allowing non-conventional style lovers to easily obtain ideal *décor* solutions.*

Tangible expressions of this commitment are the ELLE, ELLEDUE and ELLETRE wash basins made of moulded cemen-finish mortar, and the range of Prefinito Cemento finished applications used for the covering and flooring components and flush to floor shower trays and tops of the Block2 line, covered with a compound made of quartz, cement and resin (see pag. 316).

Elle

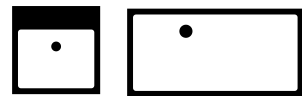

ADI Index
2002

Elledue

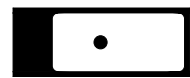

Elletre



ADI Index
2014

Linea di lavabi sospesi e da appoggio in composti cementizi trattati con additivi idrorepellenti, elasticizzanti e stabilizzanti, in vari colori.

Dedicato a coloro che ricercano arredi capaci di rappresentare l'innovazione stilistica ed estetica, sebbene siano stampati, mantengono un aspetto artigianale.

Line of wall hung and above inserted wash basins made of cement finish mortar with water-repellent, elasticizing and stabilizing additives available in many colours.

These molded elements maintain a hand-made appearance that is dedicated to the discerning client seeking innovation in the style and aesthetics of interior décor.



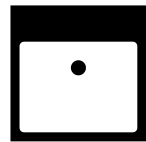

LC45 (Elle)

Lavabo LC45 sabbia
in versione appoggio
su piano in legno di
recupero ITR45. Mensola
in lamiera forata e
verniciata ITL160.

*Sand coloured LC45 wash
basin, over a re-used
wood top ITR45. Painted
sheet metal top ITL160.*



cemento sintetico:
syntetic concrete:

bianco
white

grigio
gray

sabbia
sand

tabacco
tobacco

nero
black

grigio piombo
lead gray

viola
purple

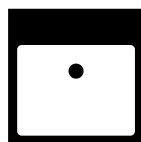

LC45 (Elle)

Lavabo LC45
bianco con
foro per
rubinetto.

*White LC45
wash basin,
with tap
hole.*



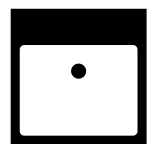

LC45 (Elle)

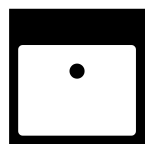

LC45 (Elle)



Lavabi LC45
bianchi con
foro per
rubinetto.

*White LC45
wash basins,
with tap
hole.*



Black LC45 wash basin on "re-used" wood top ITR (Industrial Line series).



LC45 nero su piano in legno di recupero di Industrial Line ITR.

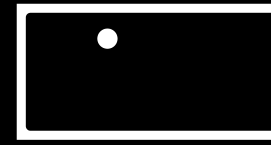

LC90 (Elle)

Lavabo sospeso in cemento sintetico grigio cm 90x45. Traversa forata in acciaio satinato (LT), asta portasalviette cm 90 (BA1). Specchio PSC cm 180.

Suspended wash basin in gray cement finish mortar 90x45 cm. Bridge shaped matt steel tray with holes (LT), towel bar 90 cm (BA1). Mirror art. PSC 180 cm.





Grey IC90 wash basin with grey beige melamine wood effect cabinet on wheels, cm 60 (art. BR6).



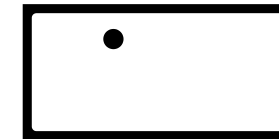

LC90 (Elle)

Lavabi sospesi in
cemento sintetico
grigio cm. 90x45.
Specchio art. PSC
cm.180. Lampada art.
BLL.

*Suspended wash basins
in gray cement finish
mortar, 90x45 cm.
Mirror art. PSC 180
cm. Lamps art. BLL.*



L2L (Elledue)

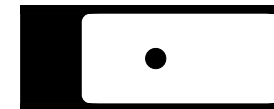

calcestruzzo:
concrete:

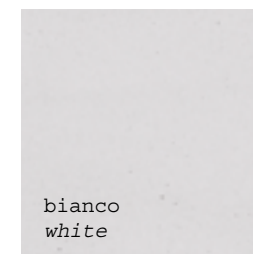

bianco
white

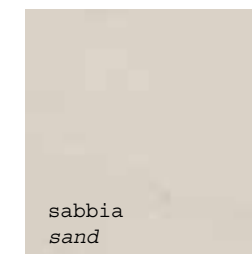

sabbia
sand



grigio
gray

L2L (Elledue)

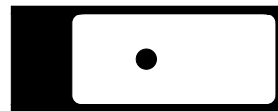

Lavabo a canale in calcestruzzo sabbia (L2L), asta portasalviette cm 100 (BA37), mensole cm 190 (BMS). Lastre cm 40x120 in Prefinito Cemento sabbia.

Canal shaped sink in sand coloured cement (L2L), 100 cm towel bar (BA37), shelf cm 190 (BMS). Cm 40x120 Prefinito Cemento wall covering panels, sand coloured.



L2L + L2C (Elledue)



Lavabo a canale in calcestruzzo grigio (L2L), contenitore a sx in rovere taglio sega caffè (L2C), rivestimenti a parete in Prefinito Cemento (cm 40x120), specchio ES150. Due pensili BQ2.

Canal shaped sink in grey cement (L2L), sawn oak coffee cabinet on the left (L2C), Prefinito Cemento wall covering panels (cm 40x120), ES150 mirror. Two wall units (BQ2).





Lavabo a canale in
calcestruzzo bianco (L2L).
*Canal shaped sink in white
concrete (L2L).*

L2L (Elledue)

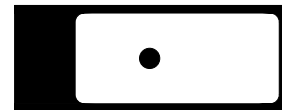

Lavabo a canale in
calcestruzzo bianco (L2L),
colonna con anta in legno
di recupero (B2C22R), asta
Strip con pensile verticale.

*Canal shaped sink in white
cement (L2L), tall cabinet
with "re-used" door
(B2C22R), Strip towel bar
with vertical unit.*





L2L (Elledue)



Lavabo a canale in calcestruzzo sabbia (L2L) e mensola bianca con asola cm 180x40 (BM), specchio SSV con lampada BLL.

Canal shaped sink in sand coloured cement (L2L), matt white shelf with a slot for the plughole cm 180x40 (BM), SSV mirror with BLL lamp.





Elletre

LA COMPIUTEZZA DELL'IMPERFEZIONE.

Morbido, irregolare, dall'aspetto imperfetto: queste le caratteristiche estetiche del nuovo lavabo in cemento Elle3 che avvicinano questo manufatto alla natura umana, rendendolo friendly. Si consolida la ricerca di Moab, sia estetica che materica, iniziata da diversi lustri, arricchita dal colore, anch'esso imperfetto e apparentemente consumato, rendendo il lavabo Elle3 adattabile a diversi gusti e ambienti.

In coordinato gli accessori, da affiancare alla struttura portante del lavabo oppure da posizionare liberamente sulla parete. Sono realizzati in metallo naturale o verniciato nei colori di gamma. Il lavabo Elle3 è disponibile in: bianco, nero, sabbia, grigio, grigio piombo, tabacco e viola, in abbinamento ai colori dei rivestimenti in Prefinito.

Dimensioni lavabo: 44x42x16

L3L (Elletre)

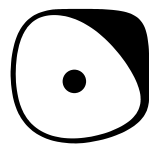

ADI Index
2014

PERFECTION OF IMPERFECTION

Soft, irregular, non perfect.

These are the aesthetical features of the new synthetic cement wash basin "Elle3" that makes this hand-made item friendly as human nature.

This Product has consolidated the research of Moab stated from several decades both from aesthetical and of matter point of view thanks to the imperfect and apparently consumed color that makes Elle3 suitable for different kind of interiors.

The new collection of accessories to be placed next to the basins' supporting frame or wall hanged, is available natural metal or paint finished.

The basin Elle3 can be supplied white, black, sand, gray, lead grey, tobacco and violet, machable with the color of our Prefiniti.

Wash-basin dimension: 44x42xH16





cemento sintetico:
syntetic concrete:



bianco
white



grigio
gray

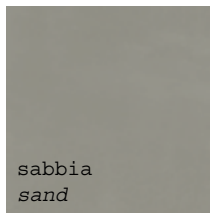

sabbia
sand

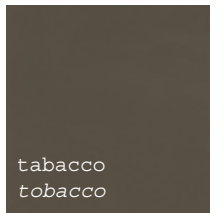

tabacco
tobacco



nero
black

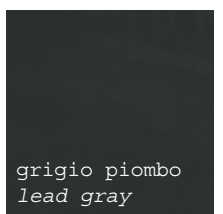

grigio piombo
lead gray

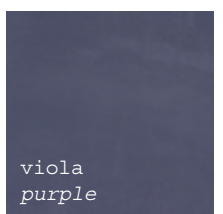

viola
purple

Coppia di lavabi in
cemento sintetico
colore viola su
parete realizzata
con Prefinito cemento
grigio chiaro;
pedana doccia in
teak su misura
(dettagli nella
sezione piatti
doccia).

*Couple of purple
synthetic concrete
wash basins L3L on a
wall with light grey
Prefinito Cemento
wall coverings;
solid teak shower
tray made to measure
FTFP (see details
in the shower tray
section).*



L3L (Elletre)

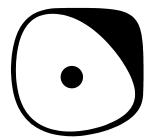

Particolare dall'alto del lavabo Elletre viola, in abbinamento con lo sgabello Nino con struttura in acciaio naturale e seduta in legno re-used.

Detail from above of the purple Elletre wash basin L3L in combination with Nino stool made out with iron legs and re-used wood seat.

Tris di lavabi
sospesi nei colori
bianco, nero e
sabbia, con e senza
foro rubinetto.
Lavabo Elletre (L3L)
in cemento nero con
specchio verticale
e accessorio porta
salviette (L3S),
disponibile nei
colori di serie.

*Tris of wall mounted
wash basin in white,
black and sand
colours, with and
without tap hole.
Black synthetic
concrete wash basin
(L3L) with vertical
mirror and towel
holder (L3S),
available in Moab80
matt colors chart.*



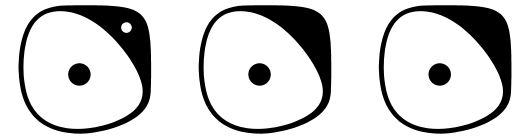

Accessori
a fascia
realizzati
in alluminio
verniciato,
disponibili
nella gamma
colori Moab.
Dall'alto:
porta
salviette con
asta bassa,
alta e ampio
contenitore
copri flaconi.



*Strip shaped
painted
aluminium
accessories,
available in
Moab80 matt
colors chart.
From the
above: towel
hanger with
lower strip
(L3-3), tall
strip (L3-
2) and large
bottle-holder
(L3-2).*





Versione Elletre da appoggio, con rubinetteria da lavabo, su desk a richiesta abbinato ai colori dei lavabi.

Above inserted Elletre (L3L) wash basin version, with tap hole. It is on a desk matched to the colors of the wash basins (item upon request).



L3L (Elletre)

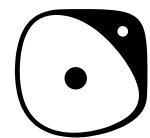

Detail of the Elletre wash basin.

Dettaglio di Elletre.





L3LCER (Elletre ceramica)

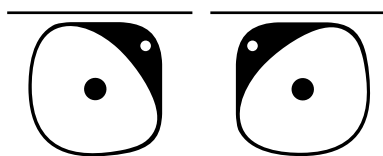

Ceramica
Ceramic



Lavabo Elletre in ceramica con piletta a scarico libero in ceramica e foro rubinetto (art. L3LCER.F).
Disponibile anche senza foro rubinetto (art. L3LCER)

Ceramic Elletre wash basin with free flow ceramic drain and tap hole (art. L3LCER.F). Available also without tap hole (art. L3LCER).

PREFINITO CEMENTO

Proposta unica nel panorama dell'offerta industriale, i Prefiniti Moab sono elementi di arredo sulla cui superficie viene applicata, come fosse una pelle, una malta cementizia o ad effetto calce.

Il Prefinito Cemento è una malta di cemento e resina dall'aspetto neutro e definito. E' il risultato di una tecnica innovativa e si presenta come una materia spatolata con una tessitura stretta e una superficie naturale, morbida e "lunare" nei riflessi.

Il progetto comprende una vasta gamma di elementi che parte dai piani lavabo su misura della linea Block2 in coordinato con mobili, pavimenti, rivestimenti, e piatti doccia filo pavimento.

Il risultato è un eccezionale sistema integrato che consente di creare atmosfere rarefatte e raffinate capace di esaltare altri elementi d'arredo complementari e offrire una grande libertà negli abbinamenti di materiali e cromatici.

E' importante sapere che i campioni di riferimento sono puramente indicativi perchè i supporti sono industriali ma l'applicazione, tramite la tecnica della spatolatura, è manuale: la tessitura quindi può variare leggermente. Questo permette di ottenere un prodotto fortemente accattivante per le sue caratteristiche contemporanee e di distinzione dai prodotti industriali che tentano di imitarne il fascino estetico.

PIANI

I piani in Prefinito Cemento sono realizzati su supporto di multistrato con incollaggio fenolico a forte spessore, predisposti per ricevere lavabi da appoggio o sottopiano, con profondità 45 e 54 cm e una lunghezza da un minimo di 70 cm ad un massimo di cm 240. Sono coordinati con i mobili della linea Block2, Door e Zero20.

MOBILI

Scocche esterne ed ante in prefinito di calce o cemento ed interno placcato alluminio.

RIVESTIMENTI, PAVIMENTI E PIATTI DOCCIA FILO PAVIMENTO

I rivestimenti in Prefinito Cemento sono realizzati su supporto industriale, disponibili in lastre su misura in grande formato, caratteristica che ne aumenta il pregio poiché è una rarità (max 100x220 cm) in integrazione con piatti doccia filo pavimento in due misure e possibilità di fuori misura a richiesta.

La loro posa in opera segue la stessa procedura prevista per altri tipi di rivestimenti, cioè l'utilizzo di guaine e collanti. Si rimanda alla lettura delle istruzioni di montaggio l'acquisizione delle specifiche utili per una corretta posa.

Prefinito Cemento and Calce finished applications are a unique proposal in the world of industrial bathroom solutions, in that they are furnishing elements over which the compound is applied, as if it were a second skin.

Prefinito Cemento is a cement and resin compound with a neutral and defined appearance. It is the result of innovative technology and is a spatula-applied product providing a close-knit texture and natural finish with soft, "lunar" reflexes.

This project includes a wide range of elements, including the made to measure sink tops of the Block2 line coordinated with furniture, floor and wall covering slabs and with flush to floor shower trays.

The result is an exceptional integrated system that allows to create rarefied and refined atmospheres capable of exalting any other complementary furnishing elements, thus offering unequalled freedom in the matching of materials and colors.

It should be noted that the samples of reference are purely indicative, since the supports are industrially made but application by spatula is entirely manual. This means that texture can vary slightly compared to the samples. Obviously, this feature provides a highly attractive product in terms of contemporary effect that is a step ahead of industrial products that attempt to imitate its aesthetic appeal.

TOPS

Prefinito Cemento finished tops are made of multi-layer support material glued extra-thick with phenol adhesive, preformed to receive vessel or under-counter mount sinks, from 45 to 54 cm deep and length ranging from a minimum of 70 cm to a maximum of 240 cm. These countertops are coordinated with the bathroom furniture of the Block2, Door and Zero20 line.

PIECE OF FURNITURE

Exterior and doors in Prefinito Calce or Cemento, Interior aluminium plated.

COVERINGS, FLOORS AND FLUSH TO FLOOR SHOWER TRAYS

Prefinito Cemento finished applications are made of a cement material support available in very large size slabs - a very special feature thanks to the rarely available size range (max 100x220 cm) that seamlessly integrate with two sizes of flush to floor shower trays (over or under sizes available on request). The laying procedures are the same as those of other covering materials, namely using sheaths and adhesives. Please consult the laying specifications for precise installation instructions.

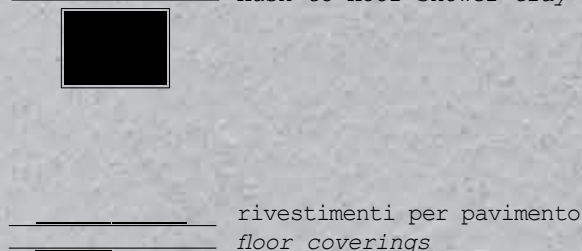
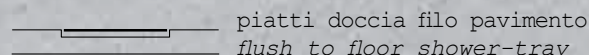
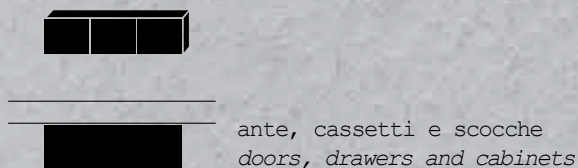
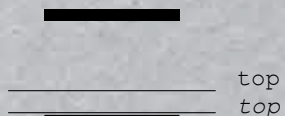

bianco - white

panna - milk white

sabbia - sand

fango - mud

tabacco - tobacco

testa di moro - very dark brown

nero - black

grigio antracite - dark grey

grigio chiaro - light grey

melanzana - aubergine

rosso - red

Composizione realizzata con top sospeso doppio lavabo in Prefinito Cemento grigio chiaro cm 240 (B2S58), profondità 54 cm, lavabi sottopiano in Corian® con scarico a scomparsa e traversa in Corian®, contenitori con anta senza maniglia bianco LL h48, specchio filo lucido cm 240. Rivestimenti a parete e a pavimento su misura in Prefinito Cemento grigio chiaro.

Composition made with suspended top 240 cm, 54 cm deep, for undertop-double sink in Prefinito Cemento light grey (B2S58), Corian® wash basins with hidden drain system and Corian® bridge-shelf, h48 base cabinets with door and without handle, white LL painting, 240x80 cm bevelled mirror. Customized wall and floor Prefinito Cemento covering panels, light grey colour.



top

rivestimenti su misura
customized covering panels





Versione integrale in Prefinito Cemento colore sabbia: pavimenti, rivestimenti, piano e contenitore serie Block2. Lavabo in Corian® semi-incassato CL7331 e specchio con cornice in metallo bianco ZS112 posizionato verticalmente.

Sand colored Prefinito Cemento integral version: wall and floor coverings, Block2 top and drawers. Semi built-in Corian® wash basin CL7331 and mirror with white metal frame ZS112 in vertical position.



top

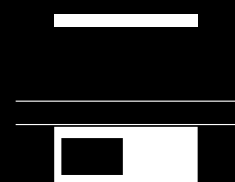

mobile

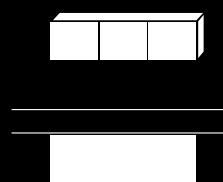

*rivestimenti su misura
customized covering panels*

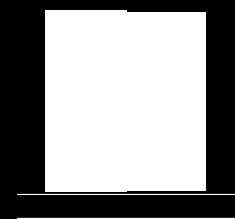

*rivestimenti per pavimento su misura
customized wall covering panels*

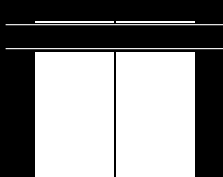



Piano H12 serie Block2 e rivestimenti a parete su misura in Prefinito Cemento colore tabacco.
H12 Block2 top and wall coverings in Prefinito Cemento, tobacco colour.



top

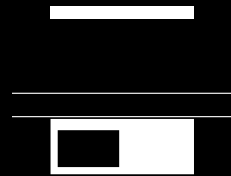

rivestimenti su misura
customized covering panels

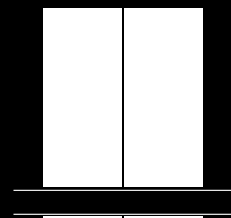

Prefinito Cemento: particolare dei rivestimenti (tabacco) e pavimenti (grigio chiaro) su misura in grande formato (max 100x220cm), specchio filo rivestimento su misura e top per lavabi sottopiano. Lavabo in Corian® con scarico a scomparsa B2L1 e mensola di collegamento B2LT.

Prefinito Cemento: detail of the wall (tobacco) and floor (light grey) slabs, large sized and made to measure (max 100 x 220 cm), mirror flush with the made to measure wall coverings and top for under-mounted sinks. Corian® wash basin with hidden drain system and bridge-shelf.



top

piatto doccia filo pavimento
flush to floor shower tray



Composizione realizzata con top cm 200, profondità 54 (B2S58) e alzata in Prefinito Cemento sabbia B2A4, lavabo sottopiano in ceramica B2L3.L, specchio filo lucido cm 200, lampada alogena BLL. Piatto doccia filo pavimento su misura, pannello con asola per piatto doccia e rivestimenti vano doccia in Prefinito Cemento sabbia.

Composition made with top, 200 cm, 54 cm deep (B2S58) and splash B2A4 in Prefinito Cemento sand colour, ceramic above inserted sink with traditional drain system B2L3.L, bevelled mirror 200 cm, halogen lamp BLL. Customized flush to floor shower tray, covering panel for shower tray in Prefinito Cemento sand colour.



rivestimenti su misura
customized covering panels

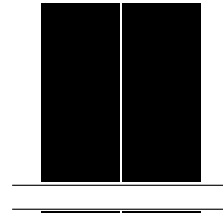

rivestimenti per pavimento
floor coverings

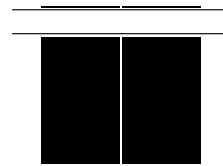

piatto doccia filo pavimento
flush to floor shower tray





Detail of the light grey Prefinito Cemento flush to floor shower tray.



Particolare del piatto doccia filo pavimento in Prefinito Cemento grigio chiaro.

Area doccia realizzata con rivestimenti, pavimenti e lastra asolata in Prefinito Cemento fango: piatto doccia FP811 di nuova generazione, alleggerito per una facile ispezione, con maniglia in PVC.



Shower area made out with wall and floor coverings, slab with hole and renewed FP811 shower tray: lightened for an easier opening, with PVC handle.



*Piatto doccia filo pavimento
su misura in Prefinito
Cemento colore grigio
antracite. Composizione di
BQ2 colore rosso pomodoro L.L.*

*Customized size dark grey
Prefinito Cemento flush to
floor shower-tray.
L.L. tomato red wall mounted
units BQ2.*

*piatto doccia filo pavimento
flush to floor shower tray*



*Piatto doccia filo pavimento
cm 110x80 in Prefinito Cemento
colore rosso (FP811) e lastra
con asola per piatto doccia
(RF1022).*

*Red Prefinito Cemento flush to
floor shower-tray cm 110x80
(FP811) and floor slab with hole
for shower-tray (RF1022).*

Prefinito Calce

Alla gamma del Prefinito Cemento, si aggiunge il Prefinito Calce, coerente nella ricerca di proposte che fanno riferimento all'area estetica non convenzionale.

Con lo stesso spirito che anima la proposta variegata dei cementi, i prodotti in Prefinito Calce (pavimenti, rivestimenti, piani, mobili, ante, cassette e piatti doccia filo-pavimento) si presentano con una finitura compatta e di media granulometria. Sono ottenuti con una lavorazione semi-artigianale e, proprio per questo, hanno un alto livello di originalità, in contrapposizione alla produzione di materiali industriali.

Particolarmente adatto ad ambienti informali e ricercati, il Prefinito Calce riproduce la finitura rude dell'intonaco nudo e crudo.

Tecnologicamente evoluta, la materia "Calce", avendo un'alta performance funzionale, è indicata anche per ambienti bagno.

Disponibile in undici colori.

Prefinito Calce

Moab 80 has added to the Prefinito Cemento tiles, the brand new Prefinito Cemento panels equally referring to the non conventional aesthetical taste.

The younger Prefinito Calce panels (available for floor, wall, wall-mounted top, cabinets, doors, drawers and shower tray) embody the same spirit of the older Prefinito Cemento tiles, featuring through a compact medium grain-size finishing. Produced thanks to the skilled work of professional artisans, these new generation of prefinished tiles keep a high level of originality, in contrast with the serial industrial production.

They are particularly suitable for non-conventional and refined interiors and reproduce the raw aspect of plaster and concrete.

Prefinito Calce applicatios are technologically advanced, high performing and recommended for bathrooms.

Available in eleven colours.

bianco - white

panna - milk white

sabbia - sand

fango - mud

tabacco - tobacco

testa di moro - very dark brown

nero - black

grigio antracite - dark grey

grigio chiaro - light grey

melanzana - aubergine

rosso - red

rivestimenti su misura
customized covering panels

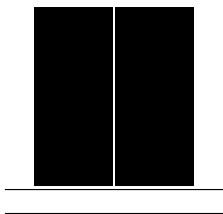

La matericità dei prodotti in Prefinito Calce in

abbinamento al forte cromatismo contemporaneo del vestibolo.

The material texture of the Prefinito Calce slabs combined with the strong contemporary colours of the vestibule.



Lastre di rivestimento in grande formato su misura in Prefinito Calce e mensole BMS, tutto colore fango.

Large sized Prefinito Calce wall coverings, made to measure, shelves, all mud colour.





Rivestimenti su misura e top H12 serie Block2 in Prefinito Calce colore fango. Specchio filo rivestimento. Mobile serie Door "re-used" con cassetti in legno di recupero, asta e pensile Strip in ferro brunito.

Prefinito Calce Block2 top and wall customised panels. Mud colour. Flush to coverings mirror. Door cabinet with "re-used" drawers, burnished iron bar and unit (Strip serie).





top

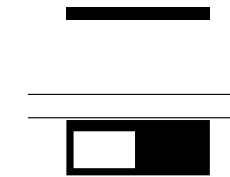

rivestimenti su misura
customized covering panels

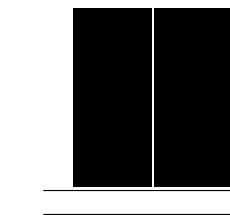

Rivestimenti su misura e top H12 serie Block2 in Prefinito Calce colore fango. Specchio filo rivestimento. Mobile serie Door "re-used" con cassetti in legno di recupero, asta e pensile Strip in ferro brunito.

Prefinito Calce Block2 top and wall customised panels. Mud colour. Flush to coverings mirror. Door cabinet with "re-used" drawers, burnished iron bar and unit (Strip serie).

rivestimenti su misura
customized covering panels

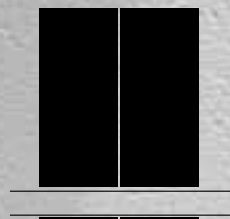

Rivestimenti e top serie block2 in Prefinito Calce bianco, lavabo in ceramica opaca. Mobile Door versione "pop".

top

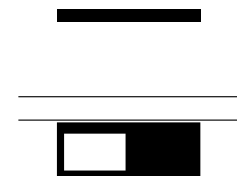

White Prefinito Calce wall coverings and Block2 top, ceramic matt wash basin. Door cabinet "pop" version.

Rivestimenti in Prefinito Calce bianco, asta Strip cm 90 e pensili orizzontali in acciaio verniciato.



White Prefinito Calce wall coverings. Cm 90 bar and horizontal units (Strip serie), in varnished steel.

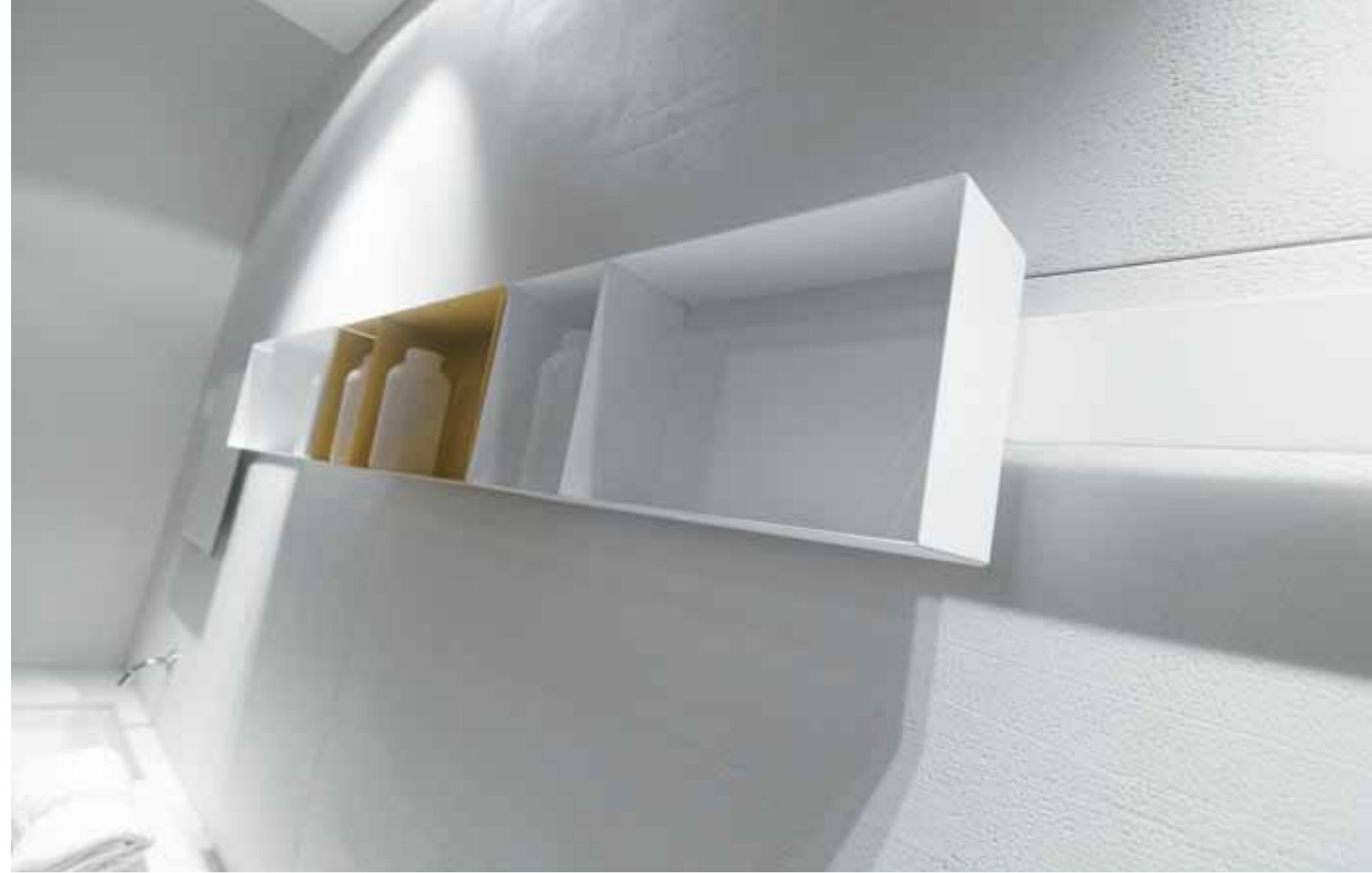

Pannello in Prefinito Calce colore nero, lavabo ILA100 colore lime, mensola in lamiera ITL nera.

Black Prefinito Calce panel, ILA100 wash basin lime coloured, varnished steel metal shelf ITL.



Composizione realizzata con pavimenti, rivestimenti, mensole a parete, piatto doccia filo pavimento e scocca del mobile Door in Prefinito Calce nera; cassetti in abete re-used, lavabo D20L colore nero.

Composition made out black Prefinito Calce flooring, wall coverings, shelves, flush to floor shower tray and Door cabinet. "Re-used" drawers and black D20L wash basin.

scocca

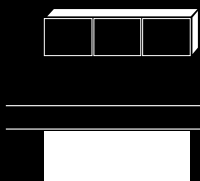

rivestimenti su misura
customized covering panels

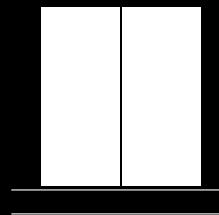

piatto doccia filo pavimento
flush to floor shower tray





Strip

STRIP è un sistema di accessori a barra con cambio profondità per accogliere sia gli accessori, collocabili liberamente sulla lunghezza meno profonda dell'asta, che le salviette. Disponibile anche nella versione rettilinea.

Alternativa ai classici singoli accessori, Strip consente la re-union delle funzioni (porta sapone, spazzolino, dispenser, salviette, mensole e rotolo) che si fondono con l'asta, avendone la stessa altezza, e regalano forza estetica all'oggetto.

Disponibili in diverse misure e diverse finiture: inox spazzolato, verniciato (colori Moab o a richiesta) o ferro brunito.

Strip

STRIP is a bar system for accessories that changes in depth in order to hold the accessories - to be positioned freely along the bar's more narrow length - as well as the towels. Available one depth version too.

As an alternative to the traditional accessories hung individually, Strip allows for the re-union of functions (soap dish, toothbrush holder, dispenser, towel hanger, shelves and paper roll) that integrate with the bar, since they have the same height, and provide the object with aesthetic power.

Available in various sizes and finishings: Brushed or varnished steel (moab or upon request colours), burnished steel.



Particolare dell'asta con 2 mensole porta oggetti (SA4, SA3) ed una vaschetta (SA2).



Detail of the bar with 2 low containers (SA4, SA3) and a high one (SA2).



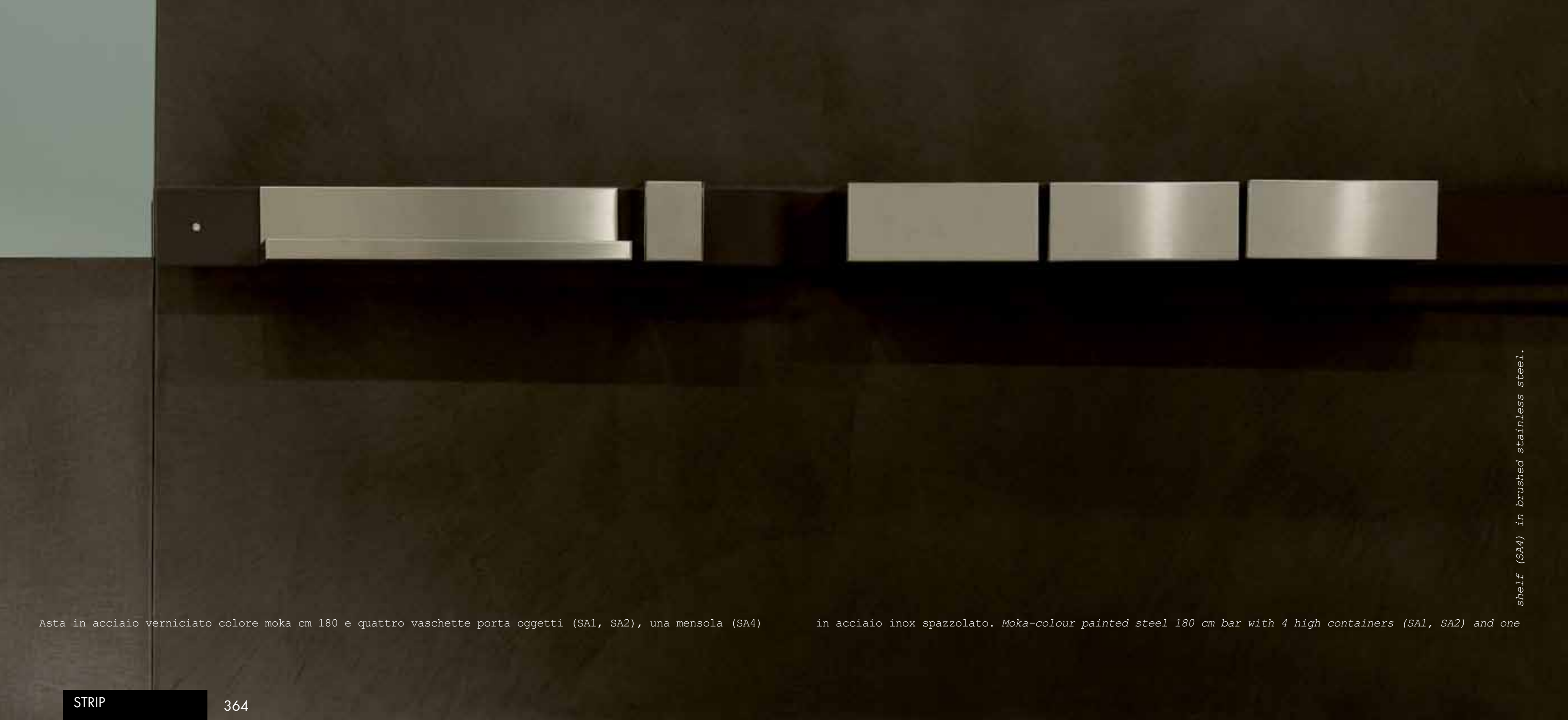

Asta in acciaio verniciato colore moka cm 180 e quattro vaschette porta oggetti (SA1, SA2), una mensola (SA4)

in acciaio inox spazzolato. *Moka-colour painted steel 180 cm bar with 4 high containers (SA1, SA2) and one*

shelf (SA4) in brushed stainless steel.



Gli accessori STRIP sono particolarmente indicati per essere abbinati ai lavabi ILA (serie Industrial Line)



con i quali condividono materiale, altezza, stile e colori. Nella foto la versione verniciata in bianco.



STRIP accessories are ideally combined with the ILA sinks (Industrial Line series) with which they share

material, height, style and colours. In the picture: white varnished version.

L'asta può essere un ideale supporto anche per specchi e salviette oppure... per le tue foto preferite.



Particolare dello specchio per asta (SA7).
Detail of the bar-mounted mirror (SA7).

The depth-changing bar can also carry mirrors and towels or... your favourite pictures.



Due barre nere
serie Strip cm 90,
pensili verticali
in acciaio
verniciato colore
nero e lime.
Sulla parete
rivestimenti su
misura in Prefinito
Calce colore
fango.

*Two black bar cm
90 (Strip serie),
vertical painted
steel units, black
and lime colour.
Prefinito Calce
customised wall
panels, mud
colour.*





Due barre nere serie Strip cm 90 (senza cambio di profondità), pensili verticali in acciaio verniciato colore nero e lime (SA9), specchio (SA8). Rivestimenti su misura in Prefinito Calce colore fango.

Two Strip bar cm 90 (one depth version), black and lime varnished painted steel units (SA9), mirror for bar (SA8). Customised size Prefinito Calcio coverings, mud colour.



Pensili orizzontali SA10 colore rosso pomodoro su barra in acciaio inox spazzolato S90.



Tomato red coloured horizontal units SA10, mounted on a brushed stainless steel bar S90.



Block Accessories

Linea di accessori da bagno a parete, su asta a misura, e da appoggio realizzati in acciaio spazzolato.
Brushed steel wall mounted bathroom accessories on customised bar or free-standing ones.

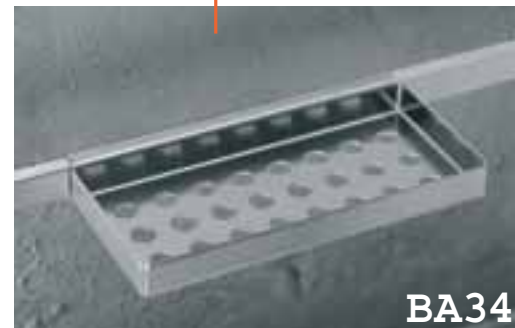
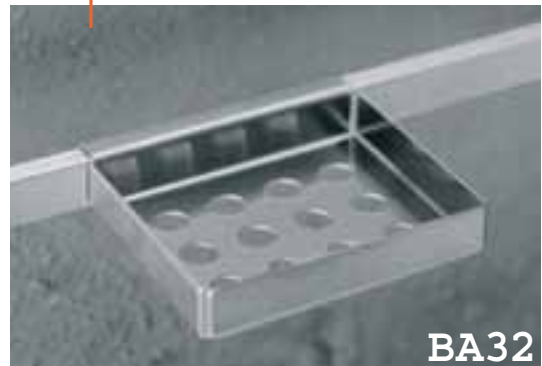
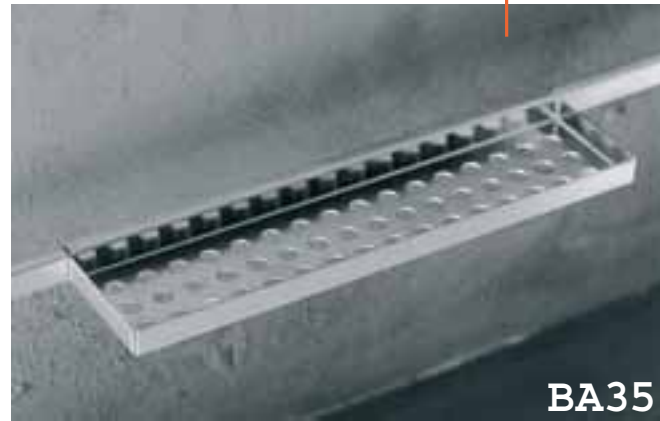



Nino

Sgabellino con seduta in Prefinito Calce, Prefinito Cemento, legno di recupero o abete sbiancato. Gambe verniciate o in ferro grezzo.

Small stool with seat available in Prefinito Calce, Prefinito Cemento, re-used wood or "pop" wood. Varnished or raw iron legs.





Nino stool in several finishings. In the foreground with "re-used" seat and iron legs.



Pavimenti, rivestimenti e seduta sgabello NINO in Prefinito Calce nero, pedana doccia filo pavimento su misura in teak (FTFP).

Wall/floor panels and stool seat in Prefinito Calce black colour, solid teak flush to floor shower dais made to measure (FTFP).





Specchi M3 in ottone
e rame brunito

*M3 burnished brass
and copper M3
mirrors.*



Composizione di
specchi M3 bianchi
ed arancio.

*Combination of
white and orange M3
mirrors.*

Luce10



design: Paolo Zani e Studio Moab

Lampada da parete in cemento sintetico colorato in pasta in sette colori. Le proprietà dell'impasto di cemento e la sua tipologia di produzione danno vita a lievi variazioni di colori e textures, rendendo ogni pezzo unico.

Cement finish mortar wall-hanging lamp coloured in the mass (seven available colours). Due to specific characteristics and artisanal production the cement blend keeps its natural appearance of different nuances and textures.



Coordinated: Luce10 and LC90 wash-basin (Elle serie) made out sand coloured cement finish mortar.



Coordinato: Luce10 e lavabo LC90 (serie Elle) in cemento sintetico colore sabbia.

Off

On



bianco
white

LUCE10

392



measures

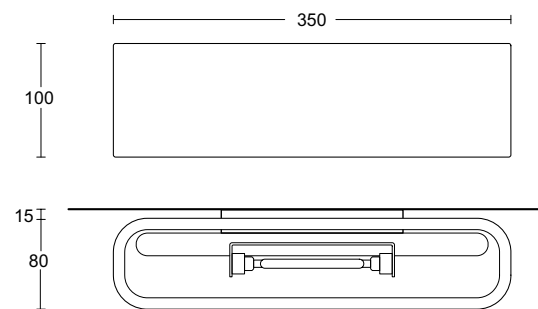

lampada alogena 220V 120W
halogen lamp 220V 120W

colours

cemento sintetico:
synthetic concrete:



bianco
white



grigio
gray

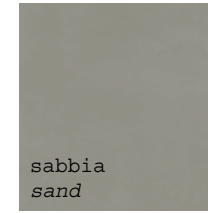

sabbia
sand



tabacco
tobacco

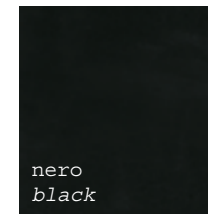

nero
black

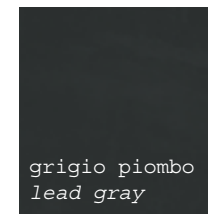

grigio piombo
lead gray



viola
purple



Piatti doccia in massello di teak

Solid teak

shower tray

Piatti doccia filo
pavimento e pedane
in teak. Quasi delle
pavimentazioni,
2 formati, anche
realizzabili su
misura. Si aggiungono
alla gamma già
in catalogo Moab
(Prefinito Cemento,
Prefinito Calce,
Corian®).

*Teak flush to floor
shower tray and dais.
Almost like a floor,
in 2 sizes, can be
made to measure.
Added to the already
existing Moab range
in the catalogue
(Prefinito Cemento,
Prefinito Calce,
Corian®).*



Area doccia composta da pedana doccia filo pavimento in teak su misura (FTFP) e piatto doccia filo pavimento

in Prefinito Calce colore nero cm 110x80 (FP811). Sgabelli NINO.P con seduta in Prefinito Calce nera e gambe



PIATTI DOCCIA teak

398

verniciate colore nero e lime.



Shower area made out solid teak flush to floor shower dais made to measure (FTFP) and black Prefinito Calce

flush to floor shower tray cm 110x80 (FP811). NINO.P stools with Prefinito Calce seats and varnished legs.

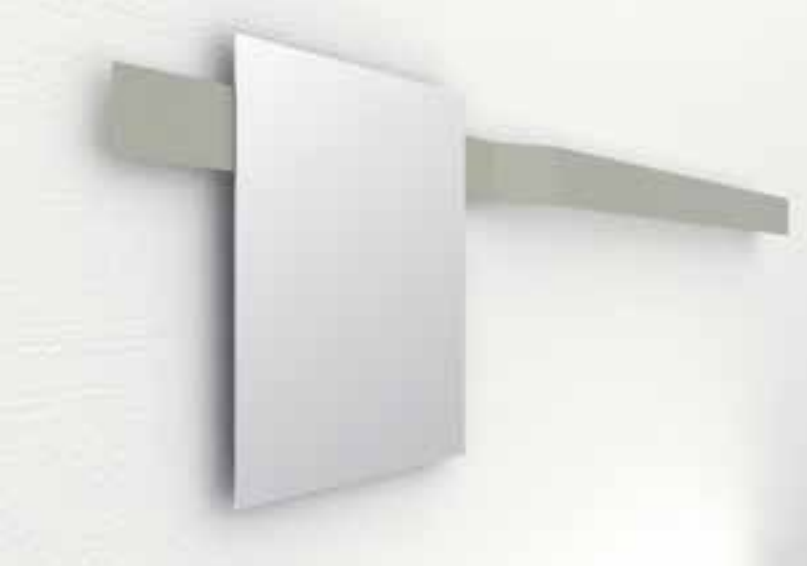

Specchio su barra cm 40x45 posizionabile a piacere (SA7), o tondo diametro 45 (SA8).
Bar-mounted mirror cm 40x45, free position (SA7), or round shaped, diameter 45 cm (SA8).



Vaschette cm 8 (SA1), cm 20 (SA2) e mensola cm 20 (SA3)
Cases cm 8 (SA1), cm 20 (SA2) and shelf cm 20 (SA3)



Porta rotolo per barra (SA5) e mensola cm 37 (SA4)
Toilet paper holder for bar (SA5) and shelf cm 37 (SA4)

Elementi STIP disponibili in: acciaio inox spazzolato, ferro brinito, verniciati colori Moab o con colori a richiesta, .

STRIP accessories available in: brushed stainless steel, burnished iron, painted in moab colours or colour on demand.

Asta porta salviette e accessori
Bar for towel and accessories

Asta porta salviette e accessori
Bar for towel and accessories

Asta porta salviette e accessori con specchio
Bar for towel and accessories with mirror



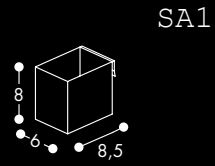

SA1

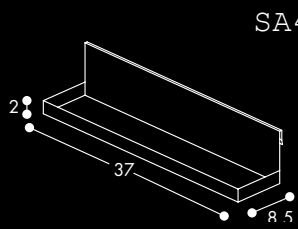

SA4

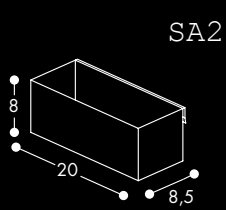

SA2

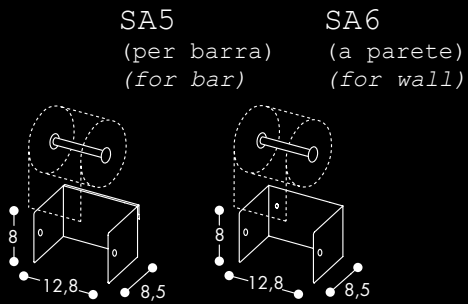

SA5
(per barra)
(for bar)

SA6
(a parete)
(for wall)

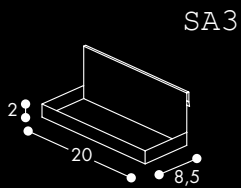

SA3

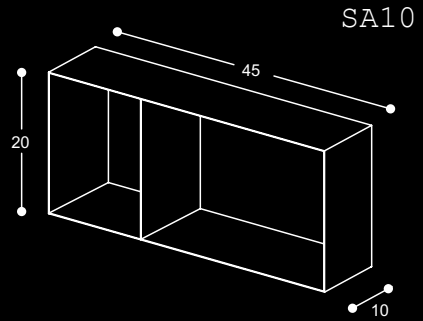

SA10

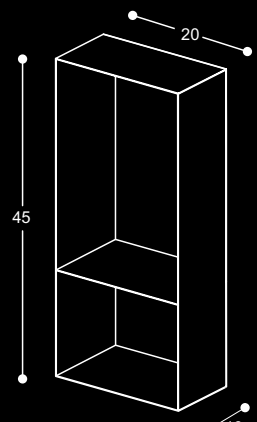

SA9

S180

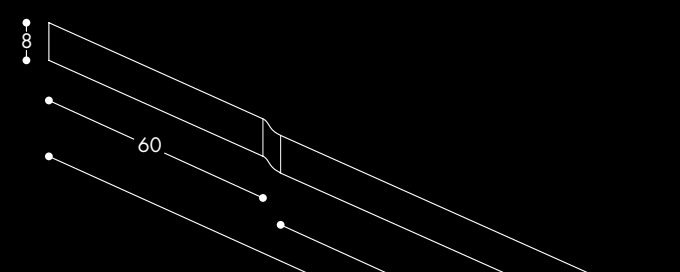

S160

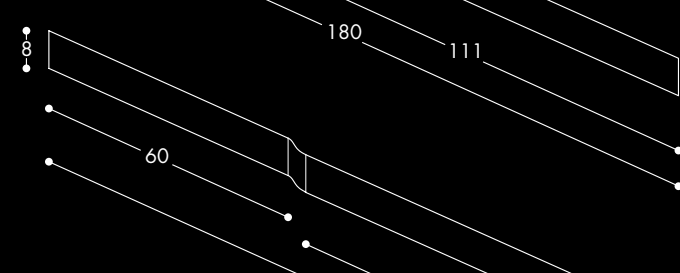

S140

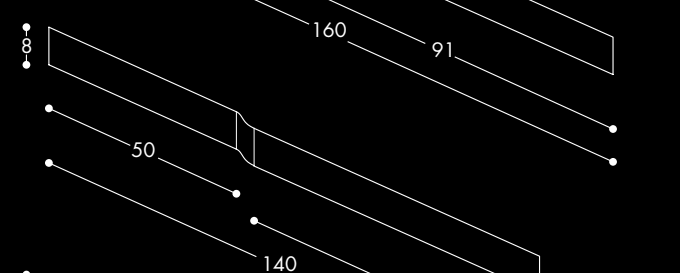

S120

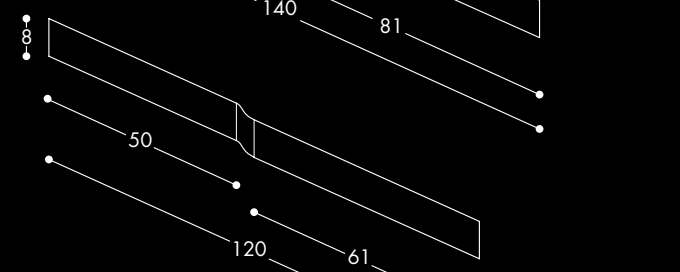

S100

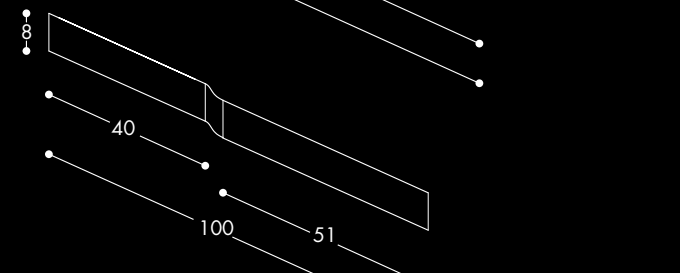

S90

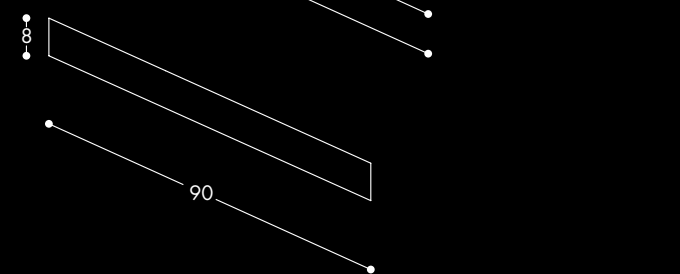

Lavabi d'appoggio in ceramica - Ceramic above inserted wash basins

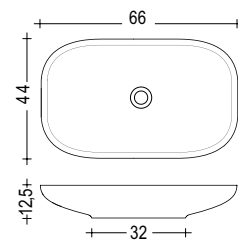
**B2LC**

Lavabo da appoggio in ceramica lucida.
Gloss ceramic above inserted wash basin.

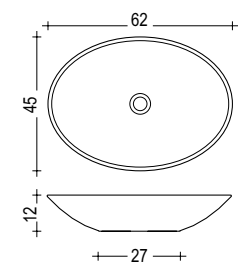
**SLC.L / SLC.O**

Lavabo da appoggio in ceramica lucida o opaca. A richiesta con piletta in ceramica.
Matt or gloss ceramic above inserted wash basin. Upon request with ceramic drain.

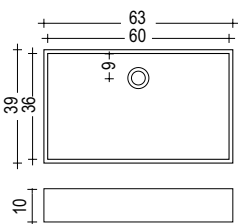
**B2BL5**

Lavabo da appoggio in ceramica lucida o opaca.
Matt or gloss ceramic above inserted wash basin.

Lavabi d'appoggio in Corian® e solid surface - Corian® and Solid Surface above inserted wash basins

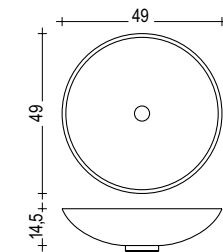
**CLAT**

Lavabo da appoggio in Corian® con scarico tradizionale. A richiesta con piletta "Click Clack" in Corian®.
Corian® above inserted wash basin with traditional drain system. Upon request with Corian® "Click Clack" basin drain.

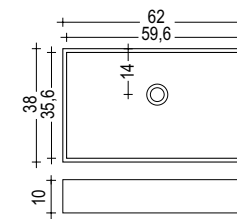
**B2BL4**

Lavabo da appoggio in Corian® con scarico tradizionale.
Corian® above inserted wash basin with traditional drain system.

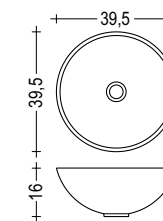
**BL37**

Lavabo da appoggio in solid surface con scarico tradizionale.
Solid surface above inserted wash basin with traditional drain system.

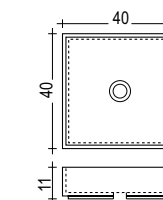
**T20L / T20LC**

Lavabo da appoggio in solid surface con/senza top di copertura. Colore bianco.
Solid surface above inserted wash-basin, with/without covering top. Colour: white.

Lavabi d'appoggio/sospesi (Industrial Line) - Above inserted/suspended wash basins (Industrial Line)

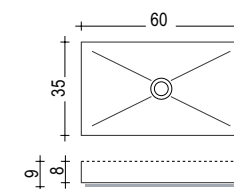
**ILA60**

Lavabo da appoggio in acciaio, varie finiture: verniciato colori Moab o a richiesta, inox "grezzo", inox spazzolato. Cm 60x35xh8. Staffa porta lavabo a richiesta (ST-ILA60).
Painted steel above inserted wash basin in various finishes: varnished in Moab or customised colours, "unfinished" stainless steel and brushed stainless steel. Cm 60x35xh8.
Supporting system on request (ST-ILA60).

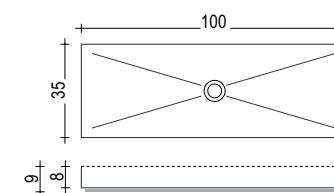
**ILA100**

Lavabo da appoggio in acciaio, varie finiture: verniciato colori Moab o a richiesta, inox "grezzo", inox spazzolato. Cm 100x35xh8. Staffa porta lavabo a richiesta (ST-ILA100).
Painted steel above inserted wash basin in various finishes: varnished in Moab or customised colours, "unfinished" stainless steel and brushed stainless steel. Cm 100x35xh8.
Supporting system on request (ST-ILA100).

Lavabi d'appoggio/sospesi (serie Elle) - Above inserted/suspended wash basins (Elle serie)

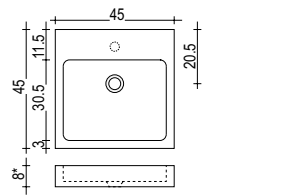

LC45

Lavabo realizzato in cemento sintetico colorato in pasta: Colori: bianco, grigio, sabbia, tabacco, grigio piombo, nero, viola; oppure in Prefinito Cemento e Calce nei colori di gamma. A richiesta con foro rubinetto. Staffa porta lavabo a richiesta (ST-LC45).

Wash basin made out with synthetic cement coloured in the mass: white, grey, sand, tobacco, lead grey, black, purple; or in the range of finishings of our Prefinito Cemento and Calce. With tap hole upon request. Supporting system on request (ST-LC45).

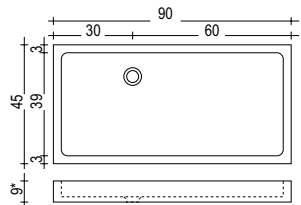

LC90

Lavabo realizzato in cemento sintetico colorato in pasta: Colori: bianco, grigio, sabbia, tabacco, grigio piombo, nero, viola; oppure in Prefinito Cemento e Calce nei colori di gamma. Staffa porta lavabo a richiesta (ST-LC90).

Wash basin made out with synthetic cement coloured in the mass: white, grey, sand, tobacco, lead grey, black, purple; or in the range of finishings of our Prefinito Cemento and Calce. Supporting system on request (ST-LC90).

Lavabi d'appoggio/sospesi (serie Elletre) - Above inserted/suspended wash basins (Elletre serie)

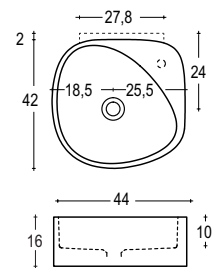

L3L

Lavabo da appoggio o sospeso in cemento sintetico senza foro rubinetto (a richiesta con foro). Colori: bianco, grigio, sabbia, tabacco, grigio piombo, nero, viola. Staffa porta lavabo a richiesta (ST-L3L).

Above inserted or wall hanging syntetic concrete wash basin without tap hole (upon request with a hole). Colours: white, grey, sand, tobacco, lead grey, black, purple. Supporting system on request (ST-L3L).

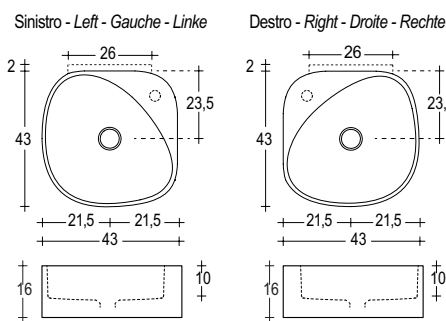

L3LCER

Lavabo da appoggio o sospeso in ceramica opaca o lucida senza foro rubinetto. Utilizzo sinistro o destro. Piletta in ceramica. Con foro rubinetto: cod. L3LCER.F. Staffa porta lavabo a richiesta (ST-L3LCER).

Above inserted or wall hanging ceramic wash basin, matt or gloss finishing without tap hole. Ceramic drain. Left or right use. With tap hole: code L3LCER.F. Supporting system on request (ST-L3LCER).

Lavabi sospesi (serie Elledue) - Suspended wash basin (Elledue serie)

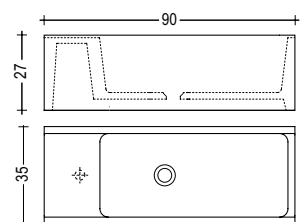

L2L

Lavabo in calcestruzzo completo di staffa porta lavabo. Colori: bianco, grigio, sabbia. Completo di struttura portante
Cement wash basin with supporting system. Colours: white, grey, sand.
With supporting frame.

Lavabi in acciaio verniciato con scarico a scomparsa - Painted steel wash basins with hidden drain system

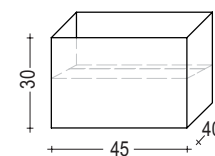

Z20L

Lavabo in acciaio verniciato con scarico a scomparsa ispezionabile. Adatto per essere utilizzato singolarmente o affiancato ai mobili serie "Zero20". Wall mounting painted stainless steel wash basin with hidden drain system (inspectable). Available loose or in combination with "Zero20" units.

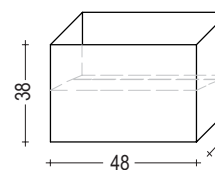

DZ20

Lavabo in acciaio verniciato con scarico a scomparsa ispezionabile. Adatto per essere utilizzato singolarmente o affiancato ai mobili serie "Door". Wall mounting painted stainless steel wash basin with hidden drain system (inspectable). Available loose or in combination with "Door" units.

Lavabi in Corian® con impianto di erogazione a scomparsa - Corian® wash basins with hydraulic built in system

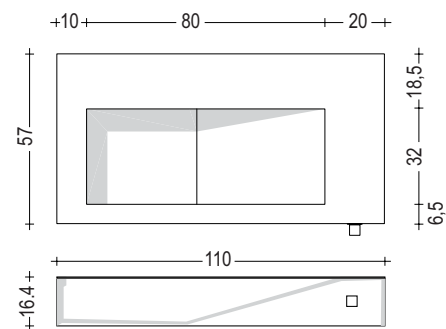

LIL110

Lavabo completo di top e impianto di erogazione acqua e scarico a scomparsa cm 110x57 in Corian® bianco. Vanity top and integrated wash basin with hydraulic built in and concealed drain system 110x57 cm made out in white Corian®.

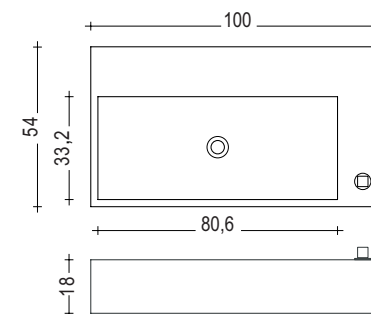

AIS

Lavabo in Corian® bianco cm 100x54xh18 completo di impianto ad erogazione acqua. White Corian® wash basin cm 100x54xh18 with hydraulic built in system.

Lavabo sottopiano in ceramica (per Block2/Door) - Undertop ceramic wash basin (for Block2/Door)

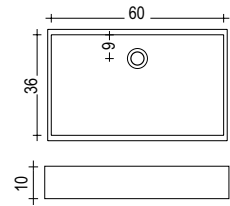

B2L3.L / B2L3.O

Lavabo sottopiano in ceramica lucida o opaca.
Gloss or matt ceramic undertop wash basin.

Lavabi sottopiano in Corian® - Corian® undertop wash basins

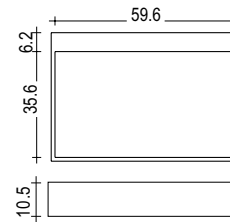

B2L1

Lavabo sottopiano in Corian® con scarico a scomparsa.
Corian® undertop wash basin with hidden drain system.

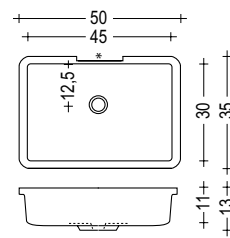

CL4530

Lavabo sottopiano in Corian® con foro per troppo pieno.
Corian® undertop wash basin with overflow.

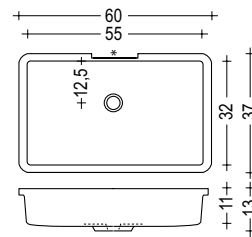

CL5532

Lavabo sottopiano in Corian® con foro per troppo pieno.
Corian® undertop wash basin with overflow.

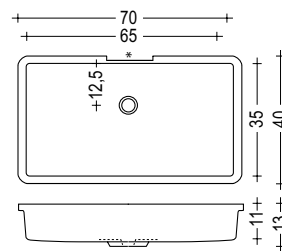

CL6535

Lavabo sottopiano in Corian® con foro per troppo pieno.
Corian® undertop wash basin with overflow.

*foro per troppo pieno
*Overflow

Lavabi sottopiano in Corian® - Corian® undertop wash basins

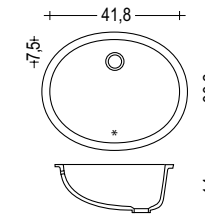

CL810

Lavabo sottopiano in Corian® con foro per troppo pieno.
NB: solo per piani di copertura mobili Block2 e Door. Non disponibile su una base Block2 con cassetti.
Corian® undertop wash basin with overflow.
NB: Only Block2 and Door cabinet covering top. Do not available on a Block2 base cabinet with drawers.

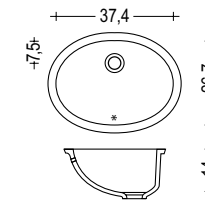

CL810

Lavabo sottopiano in Corian® con foro per troppo pieno.
NB: solo per piani di copertura mobili Block2 e Door. Non disponibile su una base Block2 con cassetti.
Corian® undertop wash basin with overflow.
NB: Only Block2 and Door cabinet covering top. Do not available on a Block2 base cabinet with drawers.

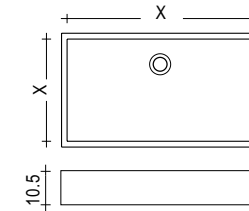

B2LX

Lavabo su misura sottopiano in Corian® con scarico tradizionale.
Corian® undertop wash basin with traditional drain system. Customized dimensions.

*foro per troppo pieno
*Overflow

Lavabi sottopiano in solid surface - Solid surface undertop wash basins

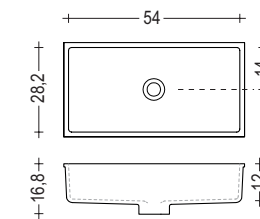

BL5728

Lavabo sottopiano in solid surface colore bianco.
Non disponibile su una base Block2 con cassetti.
White solid surface under-top wash basin.
Do not available on a Block2 base cabinet with drawers.

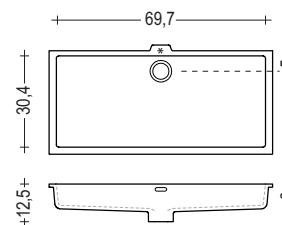

BL7030

Lavabo sottopiano in solid surface colore bianco con foro per troppo pieno.
White solid surface under-top wash basin, with overflow.

*foro per troppo pieno
*Overflow

Lavabi soprapiano in Corian® (per serie Block2 / Door) - Corian® semi built-in wash-basin (for Block2 / Door)

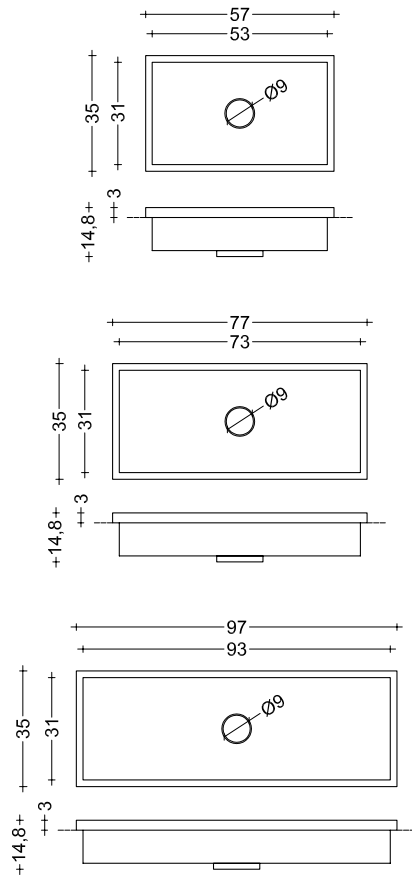

CL5331

Lavabo soprapiano in Corian® con piletta in Corian® a scarico libero.
 NB: non per piani H8, H6, H4.5.
 Corian® semi built-in wash basin with Corian® free drain.
 Not suitable with H8, H6, H4.5 tops.

CL7331

Lavabo soprapiano in Corian® con piletta in Corian® a scarico libero.
 NB: non per piani H8, H6, H4.5.
 Corian® semi built-in wash basin with Corian® free drain.
 Not suitable with H8, H6, H4.5 tops.

CL9331

Lavabo soprapiano in Corian® con piletta in Corian® a scarico libero.
 NB: non per piani H8, H6, H4.5.
 Corian® semi built-in wash basin with Corian® free drain.
 Not suitable with H8, H6, H4.5 tops.

Lavabi sottopiano e semi-incasso (Block serie) - Undertop and semi built-in wash-basin (for Block2 serie)

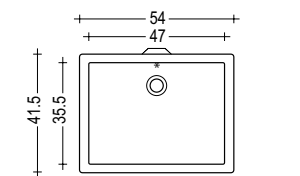

BL4

Lavabo ceramica sottopiano rettangolare con foro per troppo pieno (per serie Block).
 Ceramic under-top wash basin rectangular, with overflow (for Block serie).

*foro per troppo pieno
 *Overflow

Top con lavabo integrato in vetro - Built-in top with melted wash-basin

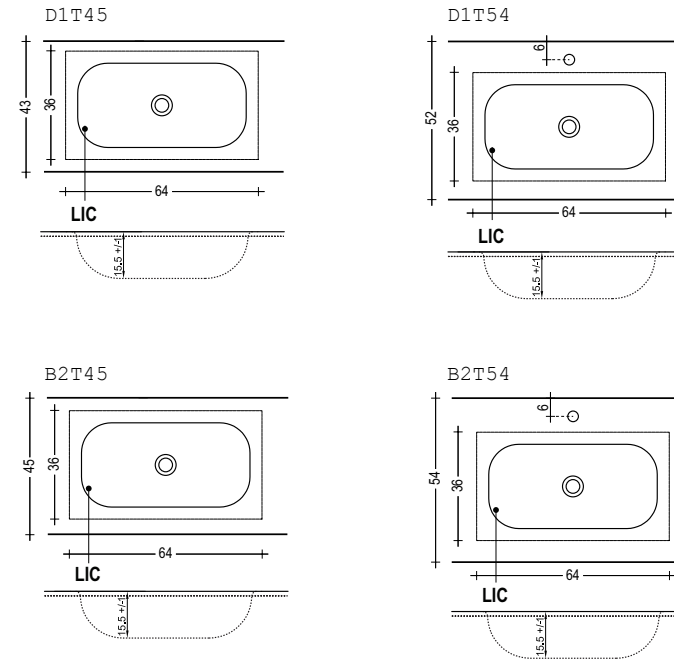

D1T45 - D1T54

Top per Serie Door con lavabo integrato (LIC) in vetro vari colori e finiture.
 Glass top with melted wash-basin (LIC) in various colours and finishing for Door serie.

B2T45 - B2T54

Top per serie Block2 con lavabo integrato (LIC) in vetro vari colori e finiture.
 Glass top with melted wash-basin (LIC) in various colours and finishing for Block2 serie.

Rivestimenti a parete e a pavimento Prefinito Cemento e Prefinito Calce
Prefinito Cemento and Prefinito Calce wall and floor coverings

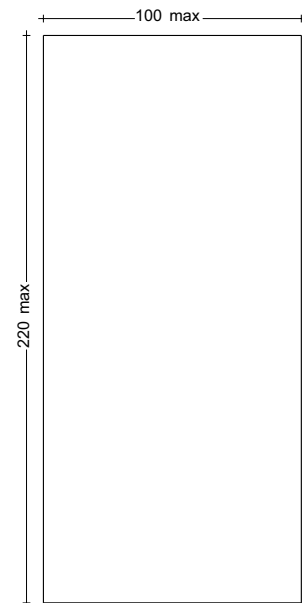

Colori Prefinito Calce: bianco, grigio chiaro, grigio antracite, sabbia, fango, rosso, testa di moro, panna, melanzana, tabacco, nero.
Prefinito Calce Colours: white, light grey, dark grey, sand, mud, red, milk white, aubergine, tobacco, black.

Colori Prefinito Cemento: bianco, grigio chiaro, grigio antracite, sabbia, fango, rosso, testa di moro, panna, melanzana, tabacco, nero.
Prefinito Cemento Colours: white, light grey, dark grey, sand, mud, red, milk white, aubergine, tobacco, black.

RM1022R

Lastra su misura da rivestimento.
Customized panel for wall.

RM1022P

Lastra su misura per pavimento.
Customized panel for floor.

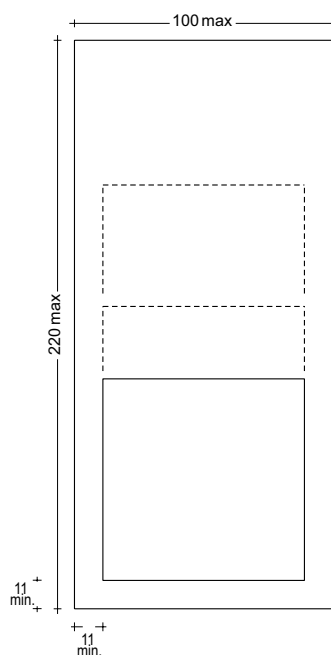

RF1022

Lastra a pavimento su misura per piatto doccia filo pavimento (max cm 110x220).
Floor slab made to measure (max size cm 110x220) for shower base flush with the floor.

Piatti doccia filo pavimento Prefinito Cemento, Prefinito Calce e Corian®
Prefinito Cemento, Prefinito Calce and Corian® flush to floor shower tray.

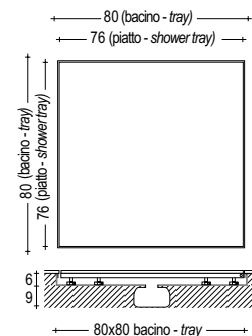

FP880

Piatto doccia filo pavimento cm 80x80.
Flush to floor shower tray cm 80x80.

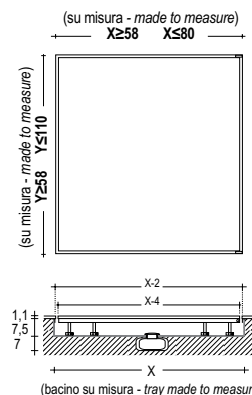

FPFM1

Piatto doccia filo pavimento su misura.
 Min. 58x58, max 80x110.
Customized flush to floor shower tray.
 Min. 58x58, max 80x110.

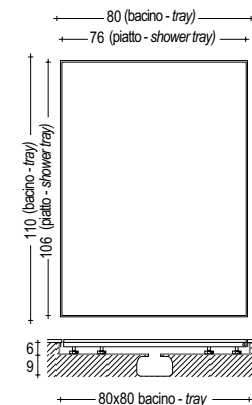

FP811

Piatto doccia filo pavimento cm 80x110.
Flush to floor shower tray cm 80x110.

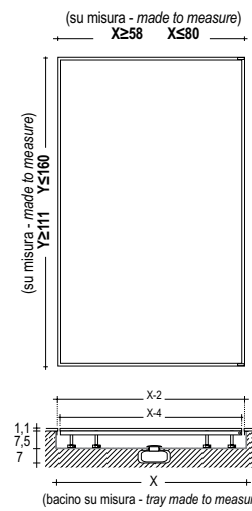

FPFM2

Piatto doccia filo pavimento su misura.
 Min. 58x111, max 80x160.
Customized flush to floor shower tray.
 Min. 58x111, max 80x160.

Piatto doccia in massello di teak - *Solid teak shower tray*

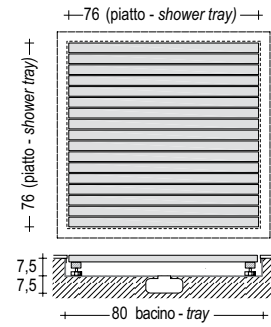

FT880

Piatto doccia filo pavimento in massello di teak. Cm 80x80.
Solid teak flush to floor shower tray. Cm 80x80.

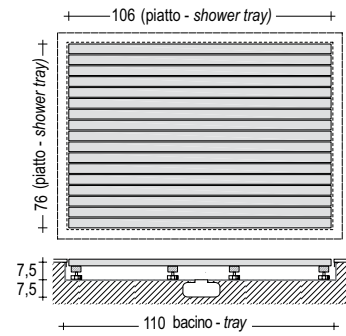

FT811

Piatto doccia filo pavimento in massello di teak. Cm 80x110.
Solid teak flush to floor shower tray. Cm 80x110.

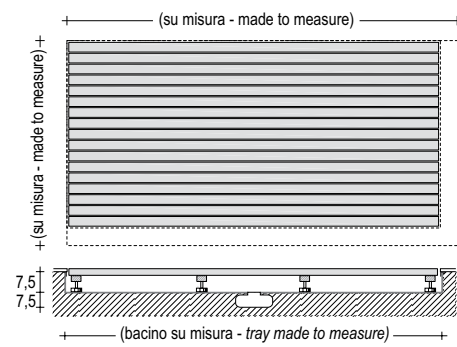

FTFM

Piatto doccia filo pavimento in massello di teak su misura.
Solid teak flush to floor shower tray made to measure.

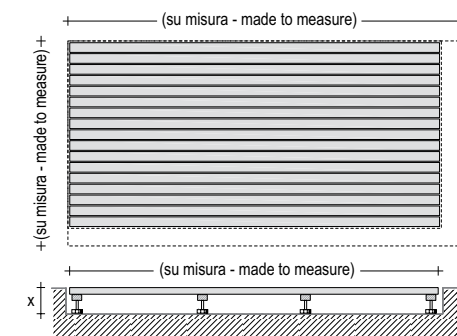

FTFP

Pedana doccia su misura in listelli di teak con piedini regolabili.
Solid teak strips shower dais made to measure, with adjustable legs.

Accessori serie Elletre - *Elletre accessories*

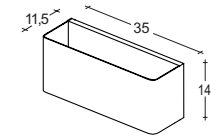

L3-1

Vaschetta porta oggetti
Holder

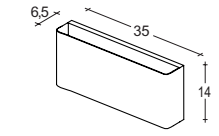

L3-2

Elemento porta salviette
Towel hanger element

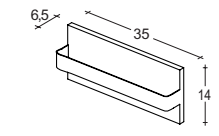

L3-3

Elemento porta salviette
Towel hanger element

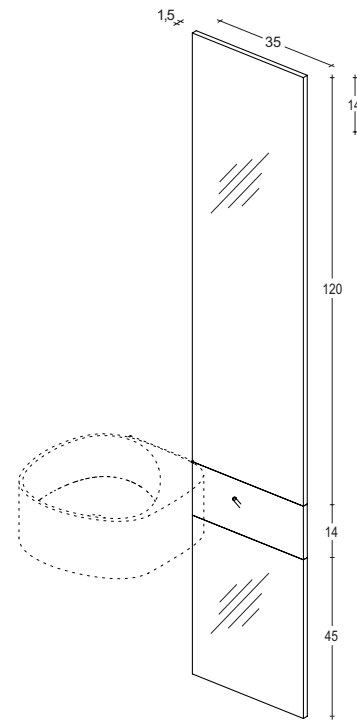

L3-S

Specchio con porta salviette. Struttura in metallo verniciato
Mirror with towel hanger. Painted metal frame.

Legni
Woods

Le texture ed i colori dei materiali e delle finiture hanno solo valore indicativo.
The textures and colours of materials and finishes are only indicative.

Rovere taglio sega
bianco
Sawn oak
white



Rovere taglio sega
naturale
Sawn oak
natural



Rovere taglio sega
beige
Sawn oak
beige



Rovere taglio sega
tortora
Sawn oak
gray beige



Rovere taglio sega
caffè
Sawn oak
coffee



Nobilitati effetto legno
Melamine wood effect

Le texture ed i colori dei materiali e delle finiture hanno solo valore indicativo.
The textures and colours of materials and finishes are only indicative.

Nobilitato rovere
bianco
Melamine oak
white



Nobilitato rovere
tortora
Melamine oak
grey beige



Nobilitato rovere
caffè
Melamine oak
coffee

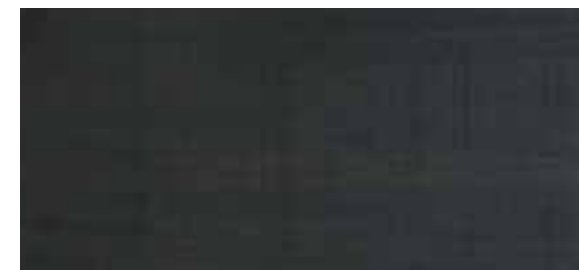

Legni serie Door, Zero20 ed Industrial Line.
 Door, Zero20 and Industrial Line woods.

"re-used"
 legno di recupero
"re-used"
 re-used wood



"pop"
 abete sbiancato
"pop"
 bleached spruce



"teak stripes"
 teak listellare
"teak stripes"
 teak stripes



Calcestruzzo (serie Elledue)
 Concrete (Elledue serie)

Calcestruzzo
 bianco
Concrete
 white

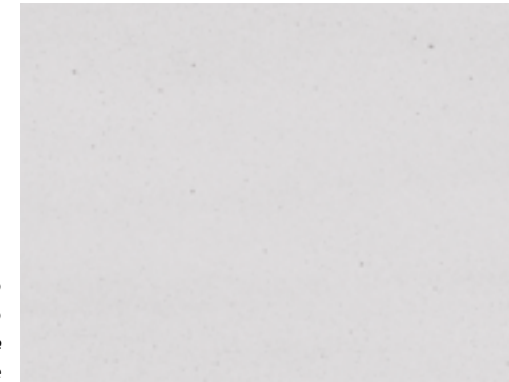

Calcestruzzo
 grigio
Concrete
 grey



Calcestruzzo
 sabbia
Concrete
 sand



Le texture ed i colori dei materiali e delle finiture hanno solo valore indicativo.
 The textures and colours of materials and finishes are only indicative.

Le texture ed i colori dei materiali e delle finiture hanno solo valore indicativo.
 The textures and colours of materials and finishes are only indicative.

Cemento sintetico (serie Elle, Elletre, Luce10)
Syntetic concrete (Elle, Elletre, Luce10 series)

Cemento sintetico
 bianco
*Syntetic concrete
 white*



Cemento sintetico
 sabbia
*Syntetic concrete
 sand*



Cemento sintetico
 grigio
*Syntetic concrete
 gray*



Cemento sintetico
 tabacco
*Syntetic concrete
 tobacco*

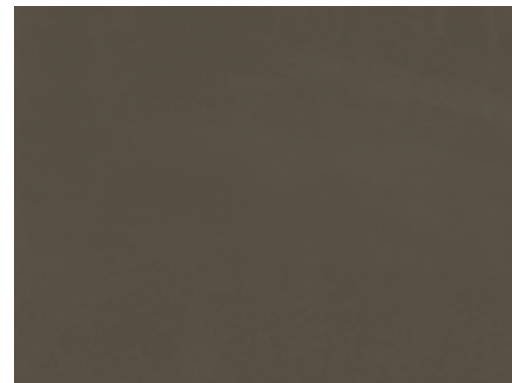

Cemento sintetico (serie Elle, Elletre, Luce10)
Syntetic concrete (Elle, Elletre, Luce10 series)

Cemento sintetico
 grigio piombo
*Syntetic concrete
 lead gray*

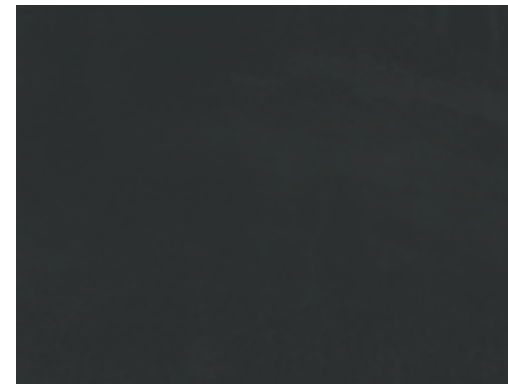

Cemento sintetico
 nero
*Syntetic concrete
 black*

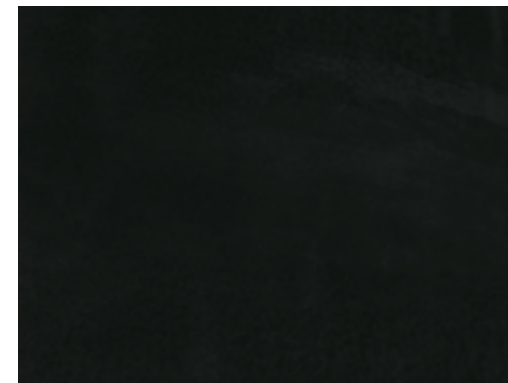

Cemento sintetico
 viola
*Syntetic concrete
 purple*



Le texture ed i colori dei materiali e delle finiture hanno solo valore indicativo.
The textures and colours of materials and finishes are only indicative.

Le texture ed i colori dei materiali e delle finiture hanno solo valore indicativo.
The textures and colours of materials and finishes are only indicative.

Prefinito Cemento
Prefinto Cemento

Prefinito Cemento
bianco
white



Prefinito Cemento
panna
milk white

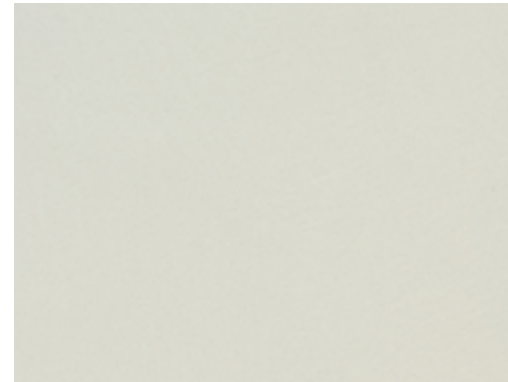

Prefinito Cemento
sabbia
sand



Prefinito Cemento
fango
mud



Prefinito Cemento
tabacco
tobacco

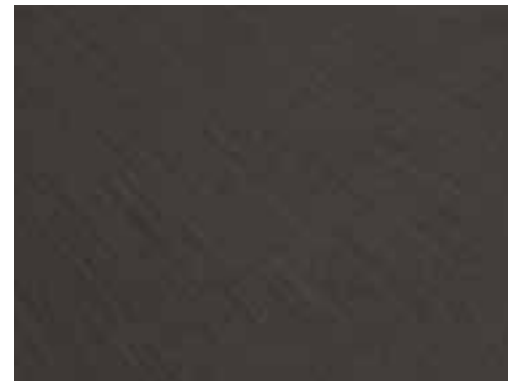

Le texture ed i colori dei materiali e delle finiture hanno solo valore indicativo.
The textures and colours of materials and finishes are only indicative.

Prefinito Cemento
Prefinito Cemento

Prefinito Cemento
grigio chiaro
light gray



Prefinito Cemento
rosso
red



Prefinito Cemento
grigio antracite
dark gray



Prefinito Cemento
melanzana
aubergine



Prefinito Cemento
nero
black

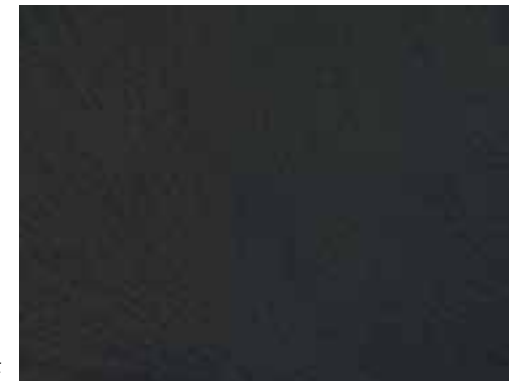

Prefinito Cemento
testa di moro
very dark brown

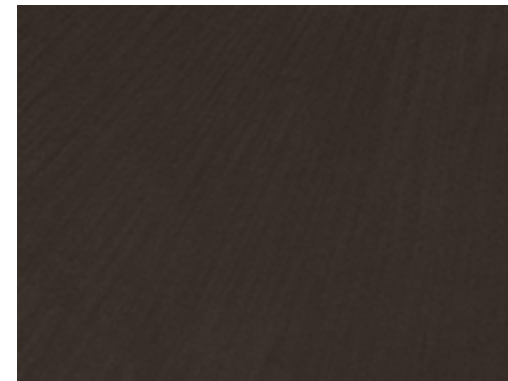

Le texture ed i colori dei materiali e delle finiture hanno solo valore indicativo.
The textures and colours of materials and finishes are only indicative.

Prefinito Calce
Prefinito Calce

Prefinito Calce
 bianco
white



Prefinito Calce
 panna
milk white

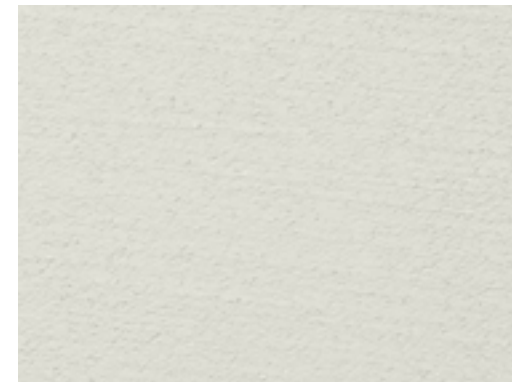

Prefinito Calce
 sabbia
sand



Prefinito Calce
 fango
mud



Prefinito Calce
 tabacco
tobacco



Prefinito Calce
Prefinito Calce

Prefinito Calce
 grigio chiaro
light gray



Prefinito Calce
 grigio antracite
dark gray



Prefinito Calce
 nero
black



Prefinito Calce
 rosso
red



Prefinito Calce
 melanzana
aubergine



Prefinito Calce
 testa di moro
very dark brown



Le texture ed i colori dei materiali e delle finiture hanno solo valore indicativo.
The textures and colours of materials and finishes are only indicative.





Le texture ed i colori dei materiali e delle finiture hanno solo valore indicativo.
The textures and colours of materials and finishes are only indicative.

Vernici opache, lucide, Laminato liquido e Cristalli smaltati
 Matt, gloss, LL paints and enamelled glass

Le texture ed i colori dei materiali e delle finiture hanno solo valore indicativo.
 The textures and colours of materials and finishes are only indicative.

bianco white	grigio chiaro light grey	grigio sabbia sand grey	tortora grey beige
beige beige	sabbia sand	fango mud	moka very dark brown
grigio scuro dark grey	nero black		
rosso pomodoro red tomato	rosso rubino ruby red	lampone raspberry	amaranto amaranth
lime lime	turchese turquoise	blu cobalto cobalt blue	giallo yellow

Metalli
Metals

Rame brunito Burnished copper	
Ottone brunito Burnished brass	
Inox spazzolato Brushed stainless steel	
Inox grezzo Unfinished stainless steel	

Le texture ed i colori dei materiali e delle finiture hanno solo valore indicativo.
 The textures and colours of materials and finishes are only indicative.



A.D.: Gabriella Ciaschi.
Product design: Gabriella Ciaschi e Studio Moab.
Graphic design: Studio Moab.
Photo: Maurizio Marcato, Matteo Rossi, Studio Moab.

Finito di stampare febbraio 2018
Stampa: Telligraf

L'azienda si riserva la possibilità di effettuare modifiche migliorative sia estetiche che qualitative.
The company reserves the right to make aesthetic and qualitative changes to the products.